

REV.	DATE	ECO	DESCRIPTION	BY	CK	APP
-	9/16/2013	N/A	INITIAL RELEASE	GDR	N/A	N/A

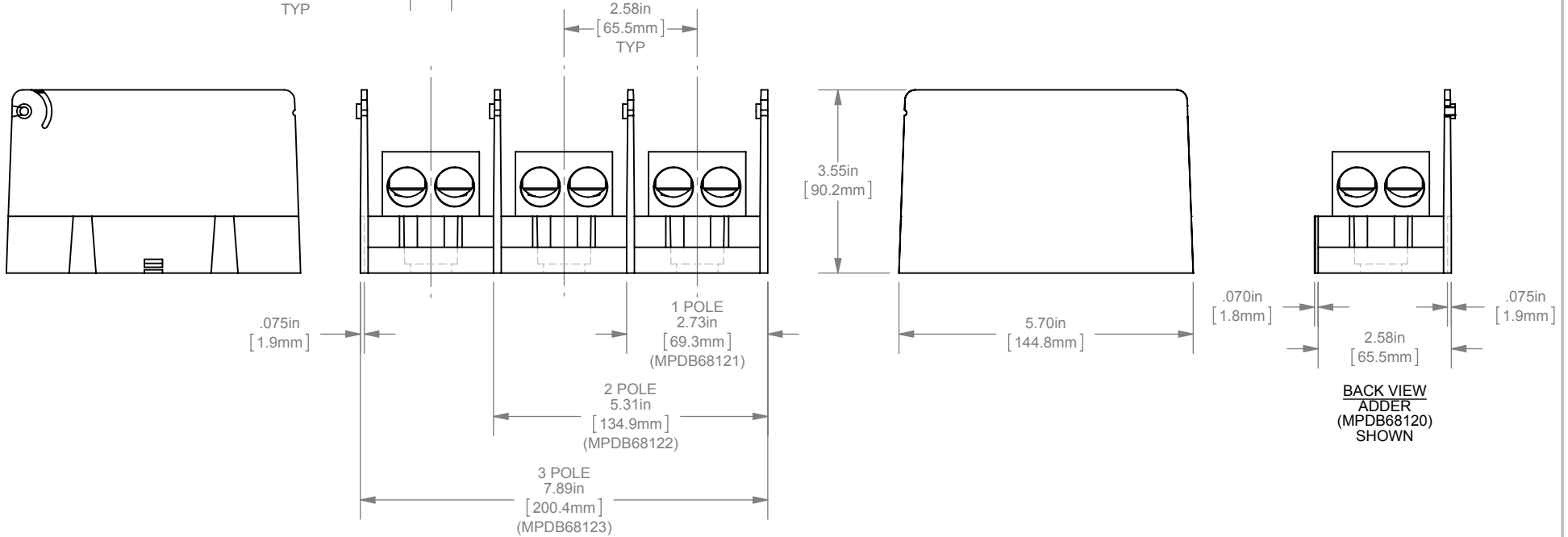

DIMENSIONS IN [] ARE MILLIMETERS

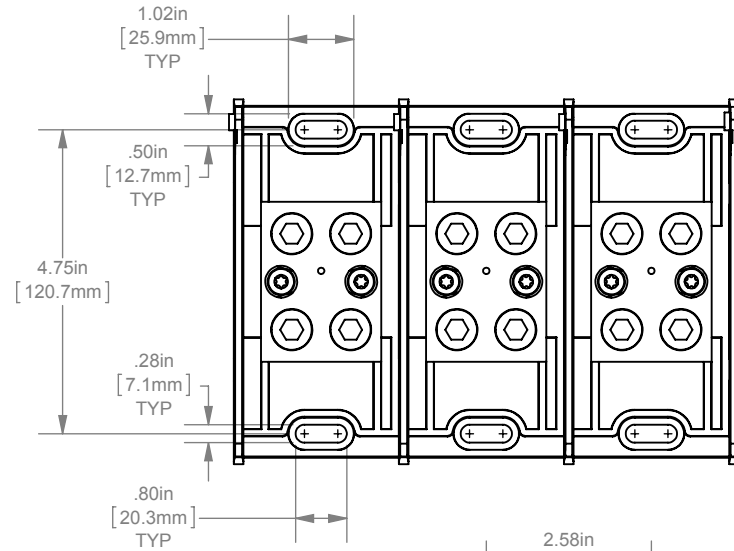

MERSEN USA NEWBURYPORT-MA, LLC
374 MERRIMAC STREET
NEWBURYPORT, MA 01950

MPDB(68120, 68121, 68122, 68123)

PDB 1-3P, ADDER CU LARGE UL1953

(2) 350-6 X (2) 350-6

OUTLINE DIMENSIONS
NOT TO BE USED FOR PRODUCTION

701993

PRODUCT MANAGER

SIGN:

DATE:

DESIGN ENGINEER

SIGN:

DATE: (SEE ECO)