

REV.	DATE	ECO	DESCRIPTION	BY	CK	APP
-	9/18/2013	N/A	INITIAL RELEASE	GDR	N/A	N/A

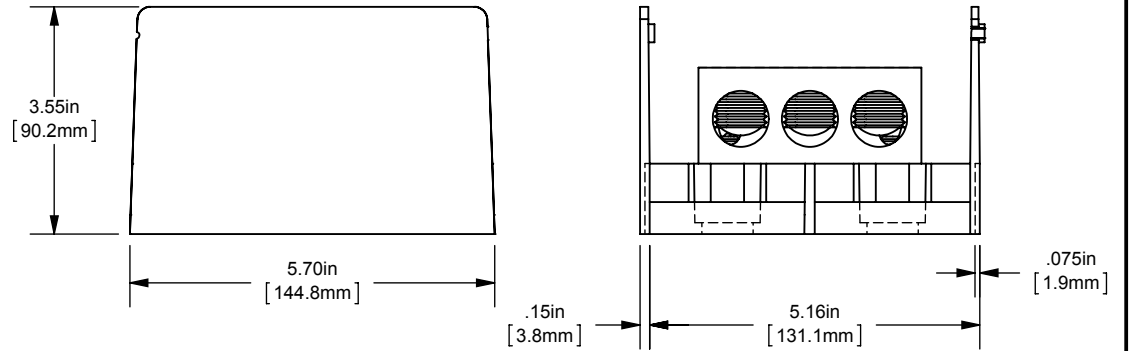

DIMENSIONS IN [] ARE MILLIMETERS

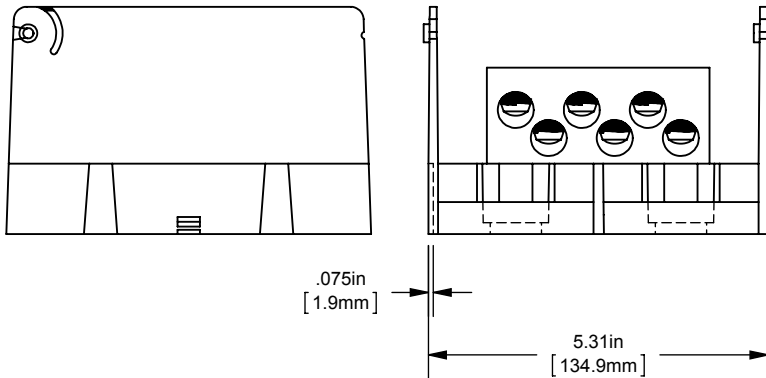
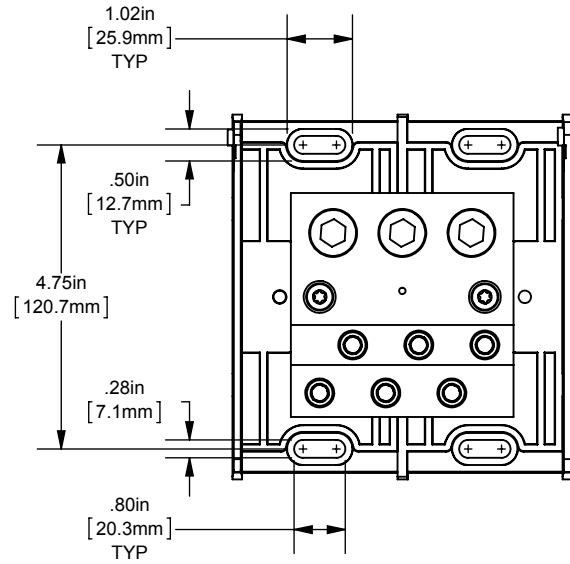

MERSEN USA NEWBURYPORT-MA, LLC
374 MERRIMAC STREET
NEWBURYPORT, MA 01950

MPDB800011

PDB COPPER LARGE DOUBLE WIDE

(3) 500-4 X (6) 4/0-10

OUTLINE DIMENSIONS
NOT TO BE USED FOR PRODUCTION

702008

PRODUCT MANAGER

SIGN:

DATE:

DESIGN ENGINEER

SIGN:

DATE: (SEE ECO)