

PRODUCT CATALOGUE



LIGHTNING
AND SURGE
PROTECTION
SPECIALISTS



INDEX

• WHY MERSEN?	3
---------------------	---

THEORETICAL CONCEPTS

• NEED OF PROTECTION	5
----------------------------	---

LIGHTNING AND SURGE PROTECTION

• RESIDENTIAL & INDUSTRIAL BUILDINGS	15
--	----

• PHOTOVOLTAIC SYSTEMS	35
------------------------------	----

• OUTDOOR LED LIGHTING	49
------------------------------	----

• GROUNDING SYSTEM MONITORING	57
-------------------------------------	----

• TELECOM & SIGNALLING NETWORKS	63
---------------------------------------	----

SPD GENERAL INSTALLATION FEATURES

• INSTALLATION & WIRING AND FUSES & FUSEHOLDERS	69
---	----

WHY MERSEN?

Expertise in power quality

Your global electrical power partner

Mersen is a leading market player with innovative solutions in the field of lightning and surge protection.

We design, manufacture, test and certify our products and your systems.

Safety & reliability for surge protection

- **Bringing together the experience** of the principal international **manufacturing and test standards** for SPDs (IEC and UL)
- **Unique expertise in the combination of SPD and fuse technology**, one of the hot topics in the SPD industry
- **Innovative ranges combining surge protection and ground monitoring** to provide full safety and continuity of service
- **World-class surge test platform**, with laboratories holding accreditations for both IEC/EN 61643-11 (Terrassa) and UL 1449 4th ed (Newburyport)
- **Global manufacturing footprint** of a comprehensive range of solutions covering both IEC and UL markets
- **Leadership in POP (TOV)** (Power-frequency Overvoltage Protection) and combined **SPD+POP** devices. EN 50550.
- Wide range of solutions targeting **industrial, commercial and residential applications**

World-class surge test platform

Mersen is committed to **innovation**. The proof of that quest for continual improvement: a total of more than a million tests in 25 years!

In the field of lightning and surge protection Mersen has a highly specialised team, test laboratories, high investment in R&D, international patents and presence on standards committees.

Mersen has two surge test labs: one in Newburyport, Massachusetts, and one state of the art Lightning and Surge protection test lab in Terrassa, Spain, namely the Global Center of Excellence for IEC Surge Protection. The two are complementary, in terms of the available resources, to be able to offer the **widest possible range of tests to IEC, UL and NFC standards**.

Lightning and surge protection

Mersen offers a wide range of solutions along with advice and consulting services as well as after sale service

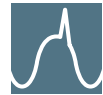

SPD – Surge-Trap®
Surge protective devices to IEC and NEMA/UL.
Also for telecom and signalling networks.
[See page 12-30](#)



GND – Grounding system monitors.



POP (TOV) – Power-frequency Overvoltage Protection.
EN 50550. (Temporary Overvoltages TOV)
[See page 31](#)



ESE – Electronic Early Streamer Emission lightning air terminals.



Mersen welcomes customers at both locations to run test campaigns focused on critical points in their own bills of requirements

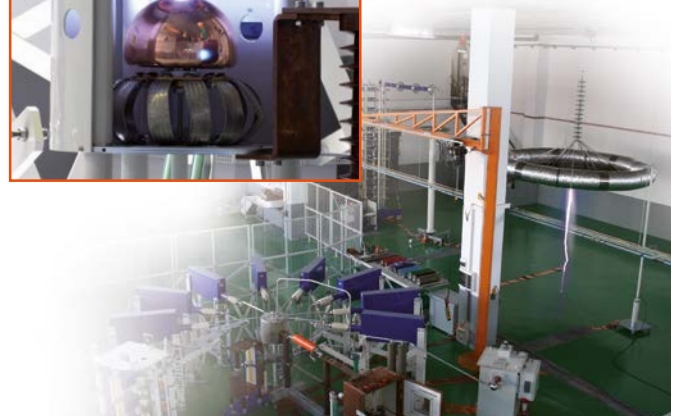

THEORETICAL CONCEPTS



NEED OF PROTECTION



- INTRODUCTION TO SURGE PROTECTION 6
- SPD FEATURES BASED ON THE IEC 61643 STANDARD 8
- TYPICAL CURRENT (ITYP), BEYOND THE STANDARD 9
- SPD PLACEMENT IN YOUR DESIGN10
- CONCLUSION: SPD PLACEMENT IN YOUR DESIGN12

INTRODUCTION TO SURGE PROTECTION

What are surges?

Surges are transient over voltages that can reach tens of kilovolts with durations in the order of microseconds. Despite their short duration, the high energy content can cause serious problems to equipment connected to the line like premature ageing of electronic components, equipment failure or disruptions to service and financial loss.

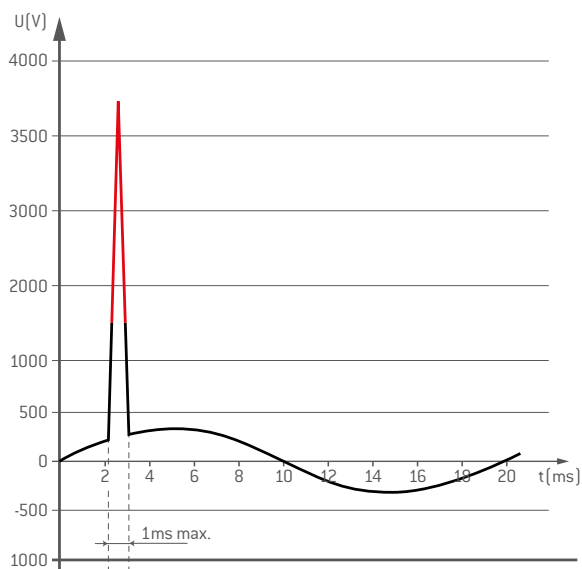

When the peak voltage reaches a value higher than the equipment can withstand, it causes its destruction.

Origin of surges

- **Lightning:** The most destructive source of surge. Based on the IEC 61643-12 standard, energy from lightning can reach up to **200 kA**. However for reference, estimates indicate 65% are less than 20kA and 85% are less than 35kA.
- **Induction:** Sources include cloud to cloud lightning or nearby lightning impacts where the current flow induces an overvoltage on supply lines or other metallic conductors.

There is no way of really knowing when, where, the size, or the duration/waveform of a surge. Therefore, within the Standards, some assumptions have been made and 2 main waveforms have been chosen to simulate different surge events.



Types of Surges

Conduction

Conduction or 10/350 μ s simulates energy from direct lightning impact

Induction

Induction or 8/20 μ s simulates energy from indirect lightning impact

Do not confuse this kA rating with the fault levels of the installation.

Fault ratings given by the transformer are kA for 1 second. Surge kA rates are for microseconds. Protection in front of surge will be based on this statement.

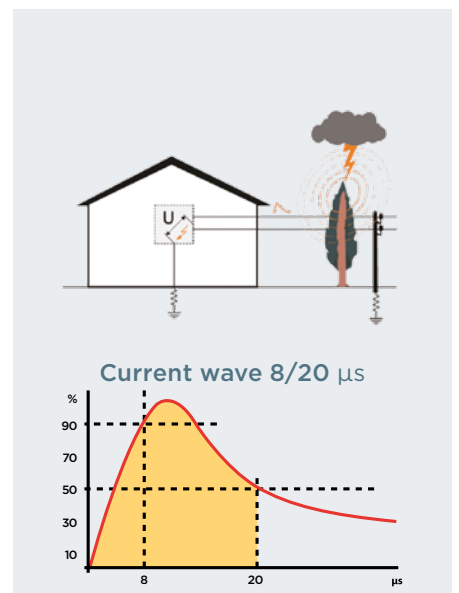
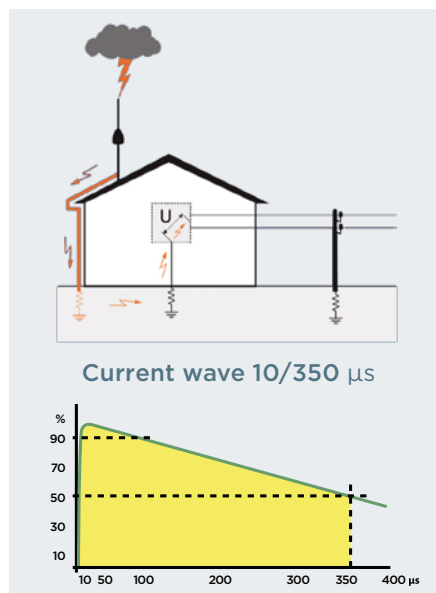

Internal surges:

These are the main sources of surge in real life

They come from utility grid switching, disconnection of motors or other inductive loads. Energy from these sources is also analysed with the 8/20 μ s wave form.

Transient overvoltages do not occur solely in power distribution lines, they are also common in any line formed by metal conductors, such as telephony, communications, measurement and data.

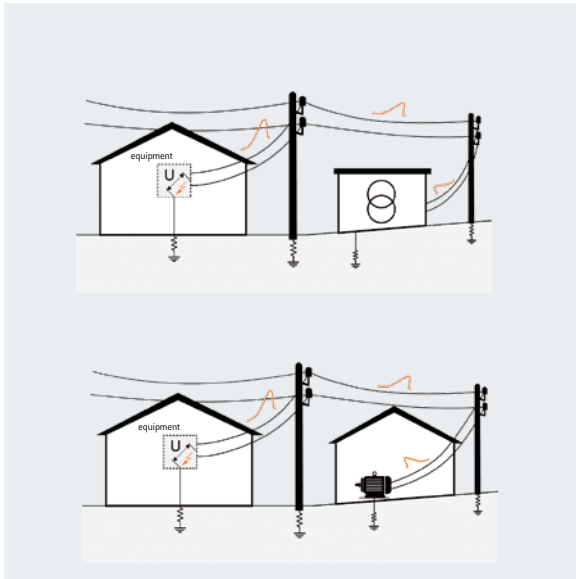

Protector in front of surges: SPD (Surge Protection Device)

A transient overvoltage protection device acts as a voltage controlled switch and is installed between the active conductors and ground in parallel with the equipment to be protected. When the supply voltage is lower than its activation voltage, the protector acts as a high-impedance element so that no current flows through it. When the supply voltage is higher than the activation voltage, the protector acts as an element with impedance close to zero, diverting the over voltage to earth and preventing it from affecting equipment downstream.

Nevertheless, in the terminals of the SPD there will always be a residual voltage (U_{res}). This is not a fixed rate. Because of the surge current, there will be a residual voltage across the SPD, this means, the higher the surge current, the higher the residual voltage. To protect your electrical equipment the residual voltage across the SPD, including the wires and connections, needs to be less than the over voltage withstand of the equipment.

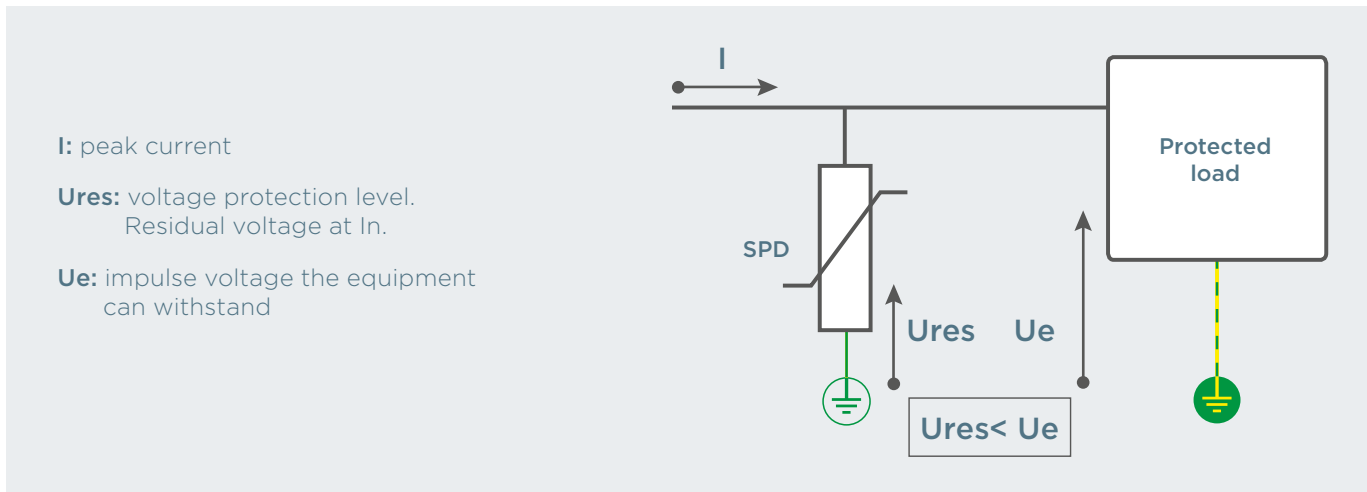

SPD FEATURES BASED ON THE IEC 61643 STANDARD

Protection parameters according to IEC 61643

Iimp

Impulse current

Peak current with 10/350 μ s waveform that the protection device can withstand without reaching end of life.

I_{max}

Maximum discharge current

Peak current with 8/20 μ s waveform that the protection device can withstand.

I_n

Nominal current

Peak current in 8/20 μ s waveform that the protection device can withstand 20 times without reaching end of life.

U_p

Voltage protection level

Maximum residual voltage between the terminals of the protection device during the application of a peak current equal to the nominal current (I_n).

U_c

Maximum continuous operating voltage

Maximum effective voltage that can be applied permanently to the terminals of the protection device.

U_{oc}

Open circuit voltage (combined voltage pulse)

This parameter is used only for the Class III test and is applicable to a Type 3 SPD. It consists of the application of a combination wave (1.2/50 μ s in open circuit - 8/20 μ s in short circuit).

Ifi

Follow current extinction capability

This parameter is only devoted to surge protectors using "air gap" technology. Once they have "switched", these surge protectors conduct part of the network current (follow current) and need to interrupt it.

Classification of protectors

Protection devices are classified into types according to discharge capacity:

- **Type 1:**

Tested with a 10/350 μ s waveform (Class I test), which simulates the current produced by a direct lightning strike.

Ability to discharge very high currents to earth, providing a high U_p - voltage protection level.

Must be accompanied by downstream Type 2 protectors. Designed for use in incoming power supply panels where the risk of lightning strike is high, for example in buildings with an external lightning protection system (LPS).

- **Type 2:**

Tested with a 8/20 μ s waveform (Class II test), which simulates the current produced in the event of a switching or lightning strike on the distribution line or its vicinity.

Ability to discharge high currents to earth, providing a medium U_p - voltage protection level. Designed for use in distribution panels located downstream of Type 1 protectors or in incoming power supply panels in areas with low exposure to lightning strikes.

- **Type 3:**

Tested with a combined 1.2/50 μ s - 8/20 μ s waveform (Class III test), which simulates the current and voltage that can reach the equipment to be protected.

Ability to discharge medium currents to earth, providing a low U_p - voltage protection level. Always installed downstream of a Type 2 protection device, they are designed to protect sensitive equipment or equipment located more than 20m downstream of the Type 2 device.

The technology can provide protection solutions that combine different types of protection: Type 1+2 and Type 2+3.



TYPICAL CURRENT (I_{TYP}), BEYOND THE STANDARD

Typical current (I_{typ}); SPD performance that guarantees the surge protection in the real life

I_{imp} , I_{max} and I_n show the one off maximum robustness of the SPDs in heavy conditions. However, most surge currents are in practice lower and repetitive because of network switching or because of lightning inductions onto the power grid.

The Typical Surge Current (I_{typ}) is the value that statistically the SPD faces in real life. The value depends on the level of exposure:

High exposed locations

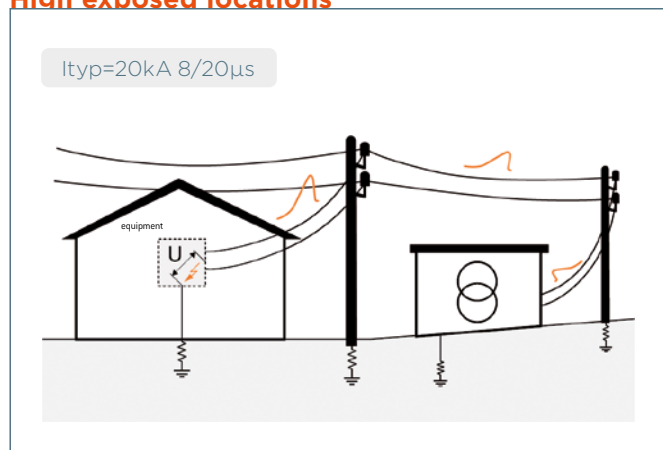

Low exposed locations or internal surges

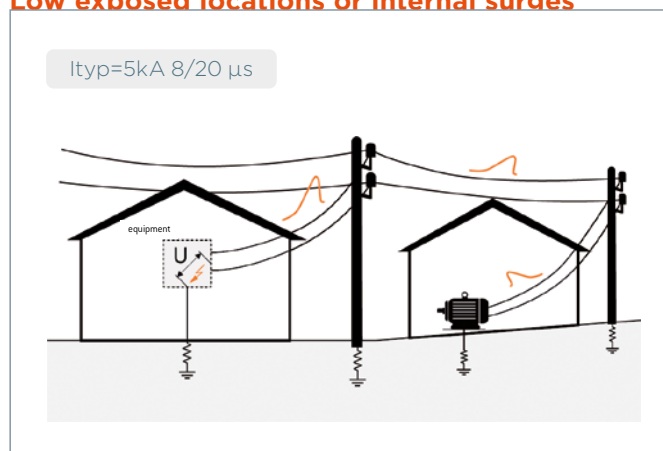

The lifetime is defined by the number of hits that **the SPD is able to withstand at Typical Surge Current (I_{typ})**.

Lifetime of the SPDs: To estimate the lifetime of the SPD is a must in order to guarantee the protection. The **SPD must be designed in order to pass the test of the standards, but furthermore to guarantee a great performance in real life.**

The minimum lifetime values that we can expect are:

- **HIGH EXPOSED LOCATIONS: 100-200 peaks.** Type 1+2 SPD requirement; usually installed in the highest exposed locations.
- **LOW EXPOSED LOCATIONS OR INTERNAL SURGES: 500 peaks** Type 2 SPD requirement; usually installed in medium or lower exposed locations.

SPD PLACEMENT IN YOUR DESIGN

When selecting an SPD, several points must be considered

1. Where to start the protection design?

At the origin of the installation, the main switchboard is the place to start the design of SPDs on the network.

2. Network typology: TNS, TNC, TT, IT, PV and No. of conductors (see page 10).

3. Nominal voltage rating (Un) of the supply. Both features will condition **the maximum continuous operating voltage (Uc)**. IEC/HD standard 60364-5-534 sets the minimum allowed value of Uc depending on the system configuration, taking into account a safety margin of the device above the nominal voltage.

4. Type 1, Type 2, Type 3 which one has to be selected?

As previously stated, the SPD protection design does not depend on the fault ratings given by the transformer, it only depends on the level of exposure in front of a surge. So, which SPD do we have to install in the main switchboard?

See the diagram below from IEC 63205-1 standard which displays the dispersion of the highest lightning considered: 200kA @ 10/350µs.

In the worst case scenario, 50% of this energy is conducted away to earth leaving 100kA potential across the networks 3 phase and neutral. Here a **25kA @ 10/350µs (Iimp) Type 1 SPD is recommended for insulated installations in extremely exposed locations to lightning.**

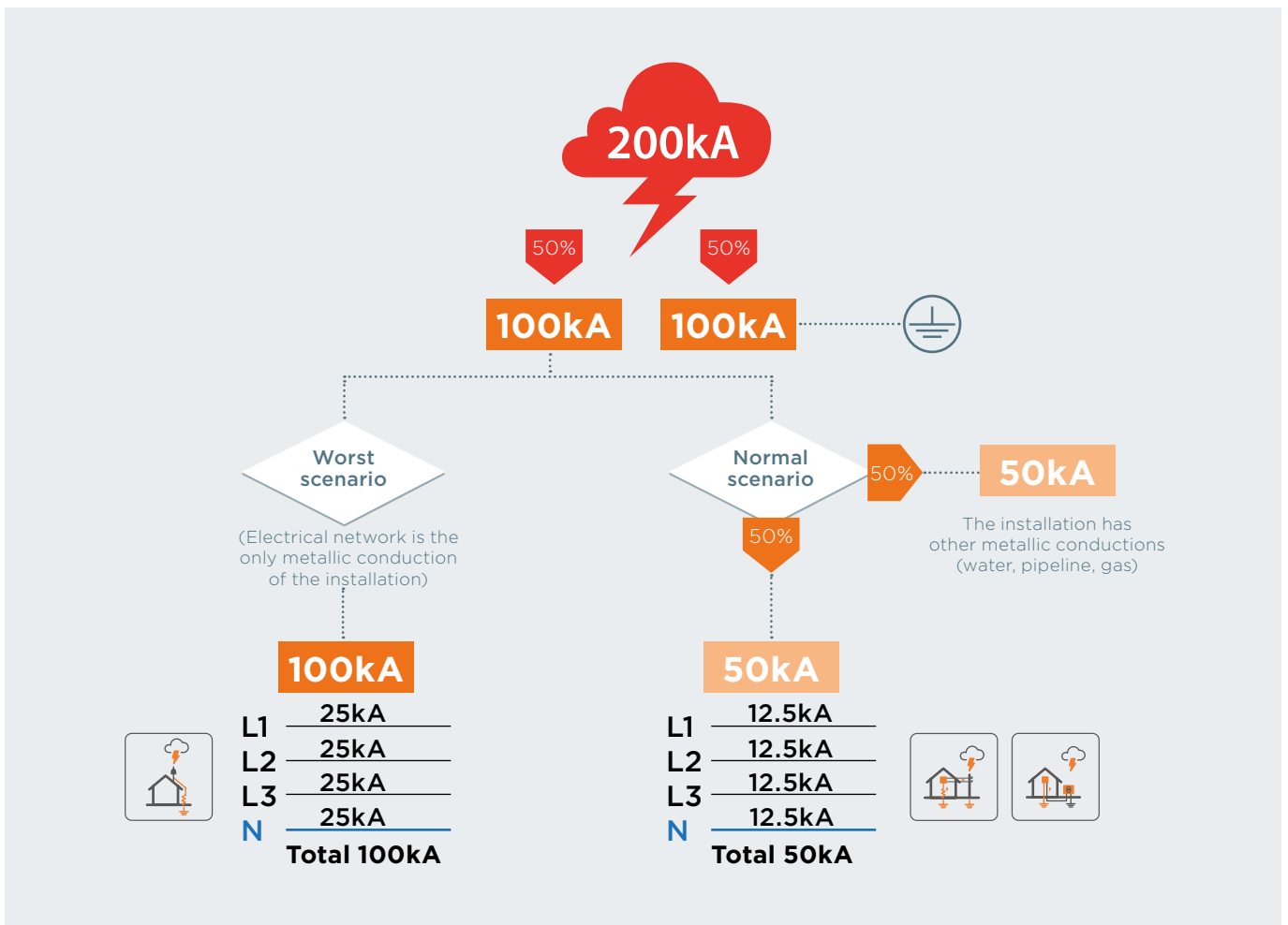

In the "Normal Scenario" it is assumed any direct lightning strike to the network will be at such a distance from the installation that another 50% of the energy is dispersed to earth via other conductors before entering your point of connection. In this scenario a device with **12.5kA @ 10/350µs (Iimp) Type 1** is recommended. **Furthermore, based on the IEC 61643-12 standard and even stated in section 534.4, 12.5kA is the minimum kA rate when a Type 1 is required.** If the level of exposure of the installation is lower than above described scenarios. Type 2 SPD (Imax) may be considered along with risk and cost of equipment and downtime.



Do we have to consider more SPDs?



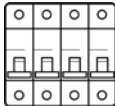





The IEC 60634-4-443 standard classifies electrical devices in categories, depending on how sensitive they are to surge over voltage (U_e). Category 1 devices (electronic receivers) are the most sensitive, U_e has to

be at least 1.5 kV. Whereas category 4 devices can withstand 6kV or more. Generally, components in main switchboards are category 4 devices ie ACB, MCCB etc.

Category	IV	III	II	I
230/400 lines	Counters / MCCB / ACB	MCBs and RCCDs	Electrical devices	Electronic receivers
Example				
Impulse voltage withstand	6kV	4kV	2.5kV	1.5kV

Then, let's consider an example below, where a Type 1+2 SPD is installed in the main distribution board of an installation. The following chart analysis the status of

the SPD, the status of the category 1 loads (the most sensitive U_e : 1.5kV) in front of different surge scenarios:

		Surge example		
		$\leq 25kA$	100kA	$> 100kA$
Iimp = 25kA Imax = 100kA In = 25kA Up $\leq 1.5kV$ In accordance with the IEC 61643-11				
$U_e = 1.5kV$ Robustness classification for electric and electronic devices according to IEC 60634-4-443				

According to the IEC 61643-1 declared Up rate is related to In. Although the SPD is able to withstand Imax probably Up level will be higher than U_e .

Statements:

- 1 - For discharges over the maximum capacity (**I_{max}**) of the SPD, the loads and the SPD itself will be damaged.
- 2 - Iimp and I_{max} define the maximum surge level the SPD itself can withstand but does not describe the protection
- 3 - Only **In** defines the level of protection as at **In** the residual voltage seen by the equipment being protected is U_e .
- 4 - As surges may be induced in cable between the main switchboard and distribution board, or by the final loads themselves, the switchboard may not be close enough to direct a surge in time to protect other final loads.

Conclusions:

- 1 - With just one stage of protection only equipment close to the SPD is protected and only up to a surge of In.
- 2 - To improve the protection possibilities, at least, a second stage of protection in a distribution board is a must. This SPD design is called cascading protection.
- 3 - Further SPDs (Type 2 and Type 3) are required to protect sensitive and critical equipment downstream of the origin of the installation when a Type 1 is fitted at the origin of installation (534.4.1.1)

CONCLUSION: SPD PLACEMENT IN YOUR DESIGN

Protection system of coordinated stages: Type 1, 2 and 3 SPDs

The SPDs of a surge protection system must be able to withstand the discharged current and provide a U_{res} level (residual voltage) lower than the U_e peak voltage that the equipment can withstand.

As explained, most of the times it is not possible to achieve this with just one SPD, especially because the intensity of the surge is not known, and because of the induction of overvoltages when conductors exceed 10m.

The optimal system of protection is the **3-STEP approach**, in which successive stages are combined in the performance of high discharge capacity devices and devices with an optimal voltage protection level (**low**). This is addressed by the definition of “Types” or “Classes” of SPDs according to the type of transient pulses to which each protected zone in the installation is subject to.

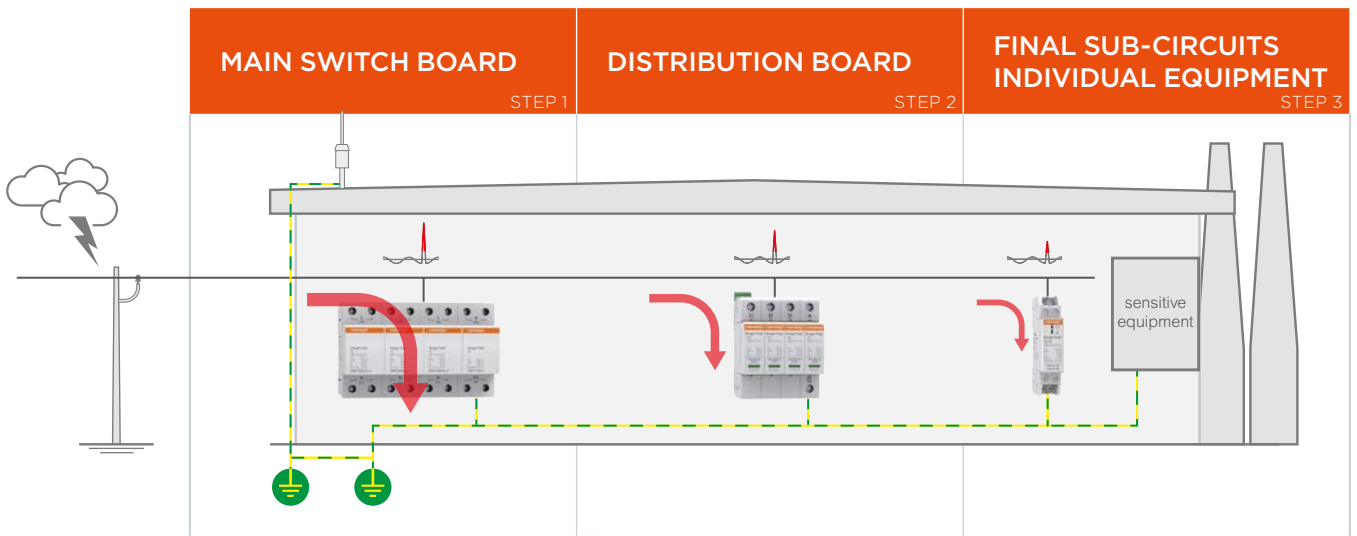

Overvoltage category IEC 60364-4-443	IV	III	II	I
Overvoltage withstand (U_e) values for equipment at 230/400V	6kV	4kV	2,5kV	1,5kV

IEC/EN 61643-11	Type 1 / Class I	Type 2 / Class II	Type 3 / Class III
Definition	Designed for use in incoming power supply panels where the risk of lightning strike is high, in particular in buildings with an external lightning protection system. Must be accompanied by downstream Class II protectors.	Designed for use in distribution panels located downstream of class I protectors or in incoming power supply panels in areas with low exposure to lightning strikes, where the building is not fitted with an external LPS.	Always installed downstream of a Class II protection designed to protect sensitive equipment or equipment located more than 20m downstream of the Class II SPD.
LPZ IEC 62305-4 protection zone	LPZ 1	LPZ 2	LPZ 3
Class test to IEC/EN 61643-11	10/350 μ s waveform, Class I test.	8/20 μ s waveform, Class II test.	Combined 1.2/50 μ s-8/20 μ s waveform Class III test.
Surge	Direct impact of a lightning strike (current).	Indirect impact of a lightning strike on the distribution line (overhead lines) or its vicinity (rise of ground potential or induction by coupling of electromagnetic radiation of the strike) or in the event of a switching.	Indirect impact simulated by the current and voltage that can reach the long-distance circuits and individual equipment to be protected.
Discharge capacity (I_{imp} , I_{max})	High	Medium	Low
Voltage protection level (U_p)	\surd (Coarse)	\surd (Fine)	\surd (Very fine)
Mersen Surge-Trap [®] series	STM T1	STP T12; STP T12 PV	
		STP T2; STP T2 PV	
			STP T23; STM T23 S; STL T23; STE T23

Do we have to consider “other” SPDs?

It is important to emphasize that when an atmospheric phenomenon causes a surge, it will be present in conduction or induction mode in all metallic cables: electrical supply **but also all communication lines, telephone, etc.**

Therefore, more protectors must be installed to **protect equipment from surges induced on control, data or communication lines.** For example, the inputs and the outputs of the PLC, communication bus, telephone lines or any antenna that the installation may have.

These protectors may be in DIN rail format and even aerial format; they must be installed as close as possible to the equipment to be protected.

In conclusion, besides the power line SPDs, it will be necessary to analyse other potential sources of surge and conclude if further protection is required and select the appropriate ones case by case.

APPLICATION	SIGNAL TYPE	FORMAT	MODEL	MERSEN PROTECTOR
DATA NETWORKS	Ethernet Cat. 5 E	DIN	STS NET CAT	 STS NET CAT Page 64
	Ethernet Cat. 6	DIN		
	Power over Ethernet, POE	DIN		
MEASUREMENT AND CONTROL	Modbus	DIN	STS 485 7V	 STS PLC 30V 4W Page 64 STS PLC 30V 2W Page 64 STS 485 7V Page 65 STS 485 5V Page 65 STS 485 5K 15V Page 65
	Profibus PA	DIN	STS 485 27V	
			STS PLC 30V 2W	
	RS 485 / 422 / RS 232	DIN	STS 485 5K 15V	
			STS 485 27V	
			STS 485 5V	
			STS PLC 30V 4W	
	4-20 mA	DIN	STS PLC 30V 4W	
			STS PLC 30V 2W	
	Device Net	DIN	STS 485 7V	
Temperature probe (PTC)				
TELEPHONE LINES	ADSL Telephony	DIN	STS TEL ADSL	 STS TEL ADSL Page 66
RADIO FREQUENCY	Coaxial signal antennas	Coaxial	STS RF	 STS RF Page 66

LIGHTNING AND SURGE PROTECTION



RESIDENTIAL & INDUSTRIAL BUILDINGS



- SURGE-TRAP® RANGE OVERVIEW 16
- SURGE-TRAP® HIGHLIGHTS 18
- SURGE-TRAP® TYPE 1 SPDS 20
- SURGE-TRAP® TYPE 1+2 SPDS 21
- SURGE-TRAP® TYPE 1+2 SPDS | STP T12 12.5 22
- SURGE-TRAP® TYPE 2 SPDS 26
- SURGE-TRAP® TYPE 2 SPDS | STP T2 40 27
- SURGE-TRAP® TYPE 2+3 SPDS 29
- SURGE-TRAP® TYPE 2+3 SPDS | STP T23 20 30

SURGE-TRAP® RANGE OVERVIEW



FIRST STEP OF PROTECTION 50kA

STM T1

See page 20



COMBINED TYPE 1+2

STP T12

See page 21



WIDE RANGE

STP T2

See page 26

Location	First step of protection		First step of protection		Second step of protection	
SPD Type	Type 1 lightning current arrester to IEC/EN 61643-11		Type 1+2 SPD to IEC/EN 61643-11		Type 2 SPD to IEC/EN 61643-11 Type 2 SPD to UL 1449 4th Ed.	
I_{imp} [10/350 μ s]	50kA (phase) / 100kA (N-PE)		12.5kA / 25kA			
I_{max} [8/20 μ s]			50kA / 100kA		40kA	
I_n [8/20 μ s]	50kA (phase) / 100kA (N-PE)		20kA / 25kA		20kA	
U_{oc} [1.2/50 μ s]						
Special features	If _i = 50kA follow current interrupt rating. Multi-sparkgap technology. Leakage current free.		ELV: Extra Low Voltage models available. Reversible & coded cartridges.		ELV: Extra Low Voltage models available. Reversible & coded cartridges.	
Supply voltage U_n (L-N/L-L)	120/208V, 230/400V, 277/480V		60V 120/208V, 230/400V, 277/480V 400/690V		48V, 60V 120/208V, 230/400V, 277/480V 400/690V + above	
Network configuration	TNS, TNC, TT	Single phase Split phase 3-phase WYE; Delta	TNS, TNC, TT, IT	Single phase Split phase 3-phase WYE; Delta	TNS, TNC, TT, IT	Single phase Split phase 3-phase WYE; Delta
Format	DIN-rail mountable. Monobloc format		DIN-rail mountable. Pluggable format		DIN-rail mountable. Pluggable format	
Type according to EN 61643-11	TYPE 1		TYPE 1+2		TYPE 2	

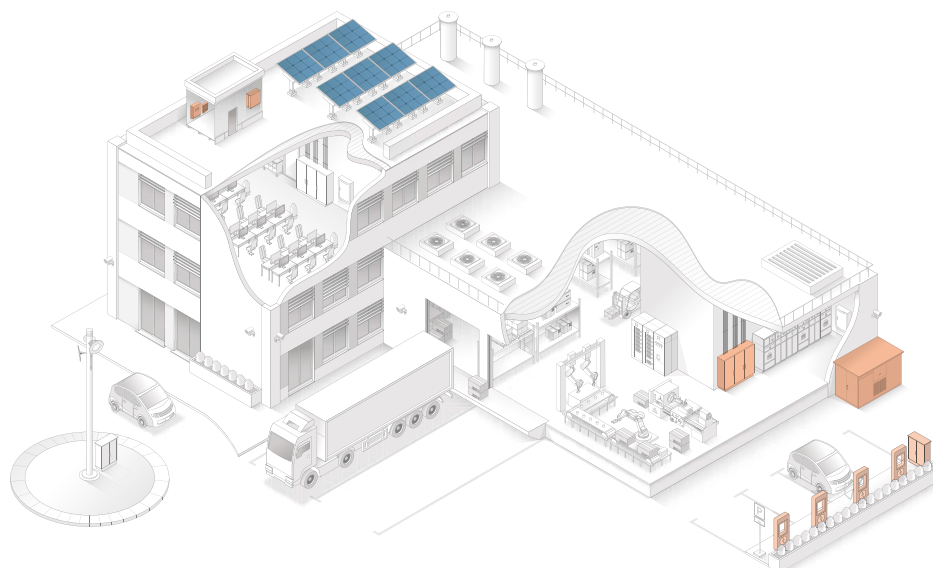

ONE SOLUTION FOR EVERY STEP OF PROTECTION



FINE PROTECTION

STP T23

See page 29



SLIM: SPACE SAVING

STM T23 SLIM

See page 32



POWERFUL EMI FILTER

STE T23 EMI

See page 33

Final stage of protection (very fine)		Final stage of protection (very fine)	Final stage of protection (very fine)
Type 2+3 SPD to IEC/EN 61643-11		Type 2+3 SPD to IEC/EN 61643 -11	Type 2+3 SPD to IEC/EN 61643 -11
20kA		20kA / 6kA	20kA
10kA		10kA / 3kA	10kA
10kV		10kV / 6kV	6kV
PLC: Power Line Communication friendly solutions (LCF). Reversible & coded cartridge.		Ideal for limited spaces [1 module].	Filter attenuation up to 82dB (common mode) vs electromagnetic disturbances. Rated current load up to 20A.
120/208V, 230/400V, 277/480V 400/690V		12V, 24V, 48V, 60V, 120V, 230V Also for use in DC voltage applications	120V, 230V
TNS, TNC, IT, TT	Single phase Split phase 3-phase WYE; Delta	Single Phase TT, TNS	Single Phase TT, TNS
DIN-rail mountable. Pluggable format		DIN-rail mountable. Monobloc format	DIN-rail mountable. Monobloc format

TYPE 2+3

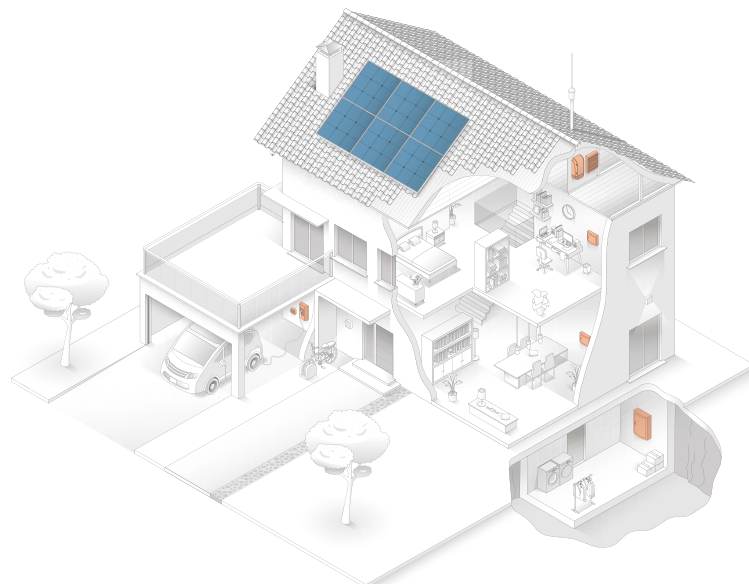

SURGE-TRAP® HIGHLIGHTS

STP Surge-Trap® Pluggable

See page 13-25



Remote indication

Dry contacts, optional in all ranges, for remote indication of protector end of life.



Biconnect connection

Two types of terminal: for rigid or flexible cable and for fork type comb busbar.

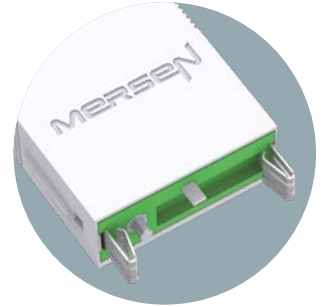

Mersen quality

Product range produced entirely by Mersen, with a thermal disconnection system. Use of the best materials and components. UL 1449 4th Ed.

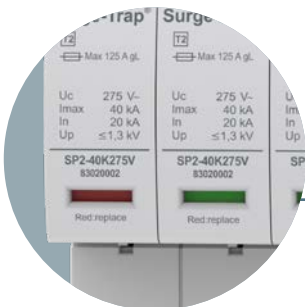

Protector lifetime status indication

Clear display of protection end of life.



Cartridge security system

Vibration proof according to the maximum levels specified in IEC 60721 (2M3 transport & 3M8 operation).

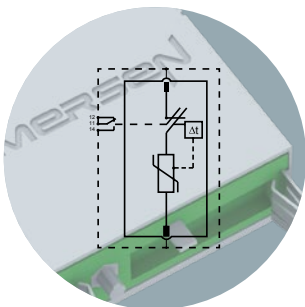

New, optimised disconnection system

Mersen has developed an optimised disconnection system for end of life. Complies with the disconnection tests of the standards for protectors for photovoltaic applications.

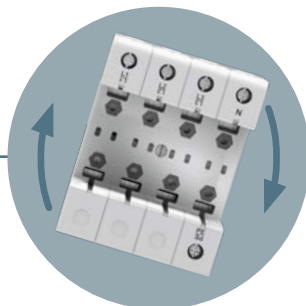

Reversible installation

Reversible chassis to allow cable entry from above or below.



Mechanical cartridge coding

Safety system to avoid possible cartridge replacement errors.

THE BEST PERFORMANCE IN THE MARKET

STM T1

See page 20

Type 1 lightning current arrester

- Discharges impulse currents with a 10/350µs waveform: 50kA per phase.
- Leakage current free (LCF).



Multi Spark Gap

- Follow current suppressing capacity. I_{fi}: 50kA.
- Low residual voltage.



STM T23 SLIM

See page 32

Status indication

- Remote and visual indication of life status of the protection device.



Type 2+3, 2 poles in 1 module

- Compact combined device (Type 2+3) for fine protection. Ideal for limited spaces.

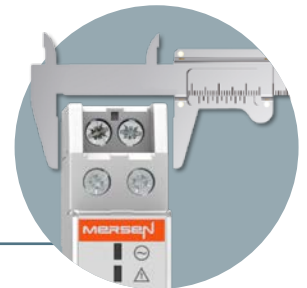

STE T23 EMI

See page 33

EMI / RFI Filter

- All models include an electromagnetic filter for network noise.

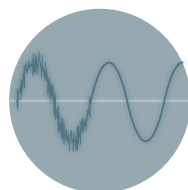

Combined SPD (Type 2+3)

- Combined devices for discharging induced transient overvoltages, while providing a very fine protection level for sensitive equipment.

STP TERRA

See page 58

TERRA® is the first protection device in the market that, in addition to indicating that it is properly wired, guarantees that there is an adequate path to earth, which is essential if the protection device is to shunt the energy peaks to earth effectively.



NO CONNECTION



POOR



CORRECT



Earth status indicator

- Continuous LED display of the earth status.

SURGE-TRAP® TYPE 1 SPDS

STM T1 50

STM T1 50 is the most robust series of single pole Type 1/Class I lightning current arresters, able to discharge energy (current) from a direct lightning strike (10/350µs) on an external lightning protection system (LPS) or overhead supplies, in accordance with IEC/EN 61643-11. Suitable as the first step of protection in incoming power supply panels and areas with high exposure to lightning strikes, fitted with an external lightning protection system.

Ratings and features

- Lightning impulse current (10/350µs): 50kA
- Follow current suppressing capacity (Ifi): 50kA
- Leakage current free (LCF)
- Multi-discharge technology
- Single pole devices for TNS, TNC, IT and TT earthing systems
- Un(L-N/L-L): 120/208V, 230/400V, 277/480V, 400/690V
- DIN-rail mountable, monobloc format



GUIDE

Example

STM T1 - 50K 275V - 1P

Surge-Trap® Monobloc Type 1 / Class I
lightning current arrester
(10/350µs)

Step 1

Lightning impulse current

- 50K** Iimp (L-N) = 50kA
- 100K** Iimp (N-PE) = 100kA

Step 2

Operating voltage

Uc	Un (L-N/L-L)
150V	120/208V
275V	230/400V
320V	277/480V
440V	400/690V
Blank	N-PE protection

Step 3

Network configuration

- 1P** L-N; 1Ph (TNS, TNC, TT, IT)
- N** N-PE; Neutral (TT Spark-Gap)

Catalogue numbers / Reference numbers

1 pole

REFERENCE NUMBER	CATALOGUE NUMBER	Network		Un [Vac]	Uc [V]	Iimp (10/350) [kA]	In (8/20) [kA]	Up@In(8/20) [kV]
		SYSTEM TYPE	ELECTRICAL DIAGRAM					
83010103	STMT1-50K150V-1P	L-N (1Ph)	A	120	150	50	50	≤2
83010100	STMT1-50K275V-1P	L-N (1Ph)	A	230	275	50	50	≤2
83010104	STMT1-50K320V-1P	L-N (1Ph)	A	277	320	50	50	≤2
83010107	STMT1-50K440V-1P	L-N (1Ph)	A	400	440	50	50	≤2,5
83010102	STMT1-100K-N	N-PE (N)	B	Neutral	255	100	100	≤2

Dimensions

1 pole

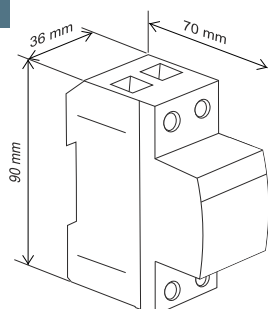

Electrical diagrams

A (1P)

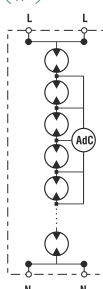

B (N)

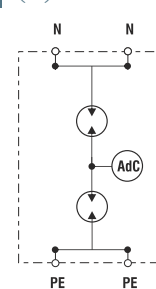

SURGE-TRAP® TYPE 1+2 SPDS

STP T12 12.5

STP T12 12.5 is the series of combined Type 1+2/Class I+II devices for discharging lightning currents and protecting against voltage surges, in accordance with IEC/EN 61643-11.

Suitable as the first step of protection in incoming power supply panels and areas with exposure to the atmosphere, where installations are usually provided with an external lightning protection system.

Ratings and features

- Lightning impulse current (10/350µs): 12.5kA per phase
- Maximum discharge current (8/20µs): 50kA per phase
- Nominal discharge current (8/20µs): 20kA per phase
- TNS, TNC, TT and IT networks
- U_n (L-N/L-L): 60V, 120/208V, 230/400V, 277/480V and 400/690V
- DIN-rail mountable, plug-in format
- Visual and remote end of life indicators
- Reversible chassis to allow cable entry from above or below
- Mechanically coded cartridges to avoid cartridge replacement errors



Approvals/Standards

- IEC/EN 61643-11
- CE



GUIDE

Example

STP T12 - 12K 275V - 4PG M

Surge-Trap® Pluggable Type 1+2 / Class I+II
combined lightning current arrester (10/350µs) and surge protective device (8/20µs)

Step 1
Lightning impulse current

- 12K** limp (L-N) =12.5kA
- 25K** limp (N-PE) =25kA
- 50K** limp (N-PE) =50kA

Step 2
Operating voltage

- | Uc | Un (L-N/L-L) |
|--------------|---------------------------|
| 75V | 60-V |
| 150V | 120/208V |
| 275V | 230/400V |
| 320V | 277/480V |
| 440V | 230/400V "IT"
400/690V |
| Blank | N-PE protection |

Step 3
Network configuration

- 1P** L-N; 1Ph (TNS, TNC, IT, TT)
- N** N-PE; Neutral (TT Spark-Gap)
- 2P** 2+0; 1Ph+N (TNS, IT)
- 2PG** 1+1; 1Ph+N (TT)
- 3P** 3+0; 3Ph (TNC, IT)
- 4P** 4+0; 3Ph+N (TNS, IT)
- 4PG** 3+1; 3Ph+N (TT)

Step 4
Remote monitoring

- M** Microswitch included

Dimensions

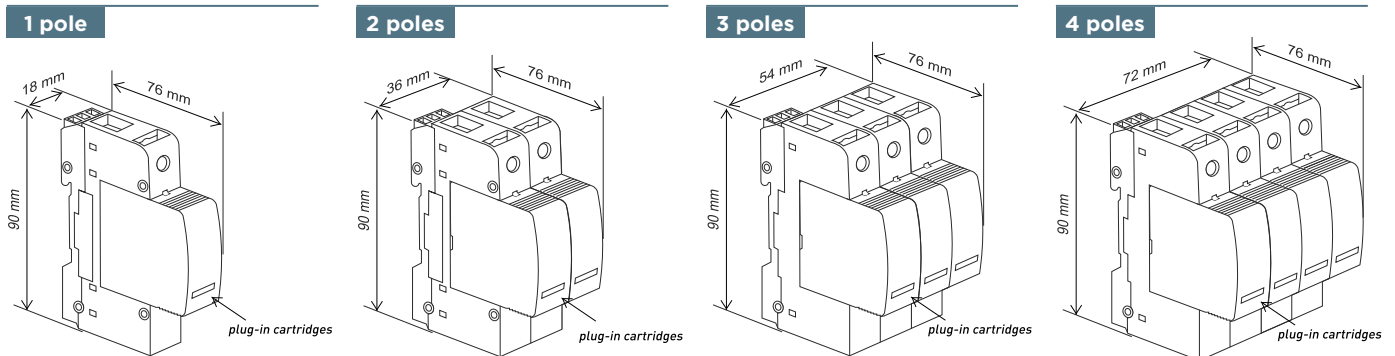

Microswitch diagram

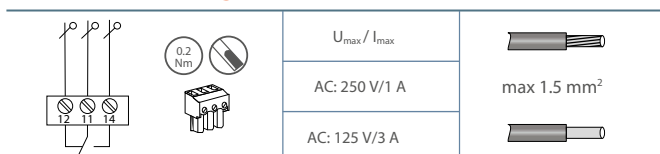

SURGE-TRAP® TYPE 1+2 SPDs | STP T12 12.5

Catalogue numbers / Reference numbers

1 pole

REFERENCE NUMBER	CATALOGUE NUMBER	Network									Cartridge Id.	
		SYSTEM TYPE	ELECTRICAL DIAGRAM	Un [Vac]	Uc [V]	Iimp (10/350) [kA]	I _{max} (8/20) [kA]	In (8/20) [kA]	Up@In (8/20) [kV]	REMOTE (M)	L	N
83120100	STPT12-12K150V-1P	L-N (1Ph)	A	120	150	12.5	50	20	≤1		C02	-
83120101	STPT12-12K150V-1PM	L-N (1Ph)	A	120	150	12.5	50	20	≤1	√	C02	-
83120102	STPT12-12K275V-1P	L-N (1Ph)	A	230	275	12.5	50	20	≤1.3		C03	-
83120103	STPT12-12K275V-1PM	L-N (1Ph)	A	230	275	12.5	50	20	≤1.3	√	C03	-
83120104	STPT12-12K320V-1P	L-N (1Ph)	A	277	320	12.5	50	20	≤1.4		C04	-
83120105	STPT12-12K320V-1PM	L-N (1Ph)	A	277	320	12.5	50	20	≤1.4	√	C04	-
83120106	STPT12-12K440V-1P	L-N (1Ph)	A	400	440	12.5	50	20	≤1.8		C05	-
83120107	STPT12-12K440V-1PM	L-N (1Ph)	A	400	440	12.5	50	20	≤1.8	√	C05	-
83120108	STPT12-25K-N	N-PE (N)	B	Neutral	255	25	50	25	≤1.5		-	C06
83120110	STPT12-50K-N	N-PE (N)	B	Neutral	255	50	50	50	≤1.5		-	C07

2 poles

REFERENCE NUMBER	CATALOGUE NUMBER	Network									Cartridge Id.	
		SYSTEM TYPE	ELECTRICAL DIAGRAM	Un [Vac]	Uc [V]	Iimp (10/350) [kA]	I _{max} (8/20) [kA]	In (8/20) [kA]	Up@In (8/20) [kV]	REMOTE (M)	L	N
83120126	STPT12-12K75V-2P	TNS (1Ph+N); PV	C	60/-	75; 80 Ucpv	12.5	50	20	≤0.65		C01	
83120127	STPT12-12K75V-2PM	TNS (1Ph+N); PV	C	60/-	75; 80 Ucpv	12.5	50	20	≤0.65	√	C01	
83120112	STPT12-12K150V-2PG	TT (1Ph+N)	D	120/-	150	12.5 (L-N) 25 (N-PE)	50	20	≤1 (L-N) ≤1.5 (N-PE)		C02	C06
83120113	STPT12-12K150V-2PGM	TT (1Ph+N)	D	120/-	150	12.5 (L-N) 25 (N-PE)	50	20	≤1 (L-N) ≤1.5 (N-PE)	√	C02	C06
83120114	STPT12-12K275V-2PG	TT (1Ph+N)	D	230/-	275	12.5 (L-N) 25 (N-PE)	50	20	≤1.3 (L-N) ≤1.5 (N-PE)		C03	C06
83120115	STPT12-12K275V-2PGM	TT (1Ph+N)	D	230/-	275	12.5 (L-N) 25 (N-PE)	50	20	≤1.3 (L-N) ≤1.5 (N-PE)	√	C03	C06
83120116	STPT12-12K320V-2PG	TT (1Ph+N)	D	277/-	320	12.5 (L-N) 25 (N-PE)	50	20	≤1.4 (L-N) ≤1.5 (N-PE)		C04	C06
83120117	STPT12-12K320V-2PGM	TT (1Ph+N)	D	277/-	320	12.5 (L-N) 25 (N-PE)	50	20	≤1.4 (L-N) ≤1.5 (N-PE)	√	C04	C06
83120118	STPT12-12K150V-2P	TNS (1Ph+N)	F	120/-	150	12.5	50	20	≤1		C02	
83120119	STPT12-12K150V-2PM	TNS (1Ph+N)	F	120/-	150	12.5	50	20	≤1	√	C02	
83120120	STPT12-12K275V-2P	TNS (1Ph+N)	F	230/-	275	12.5	50	20	≤1.3		C03	
83120121	STPT12-12K275V-2PM	TNS (1Ph+N)	F	230/-	275	12.5	50	20	≤1.3	√	C03	
83120122	STPT12-12K320V-2P	TNS (1Ph+N)	F	277/-	320	12.5	50	20	≤1.4		C04	
83120123	STPT12-12K320V-2PM	TNS (1Ph+N)	F	277/-	320	12.5	50	20	≤1.4	√	C04	
83120124	STPT12-12K440V-2P	IT (1Ph+N); TNS(1Ph+N)	C	230/-; 400/-	440	12.5	50	20	≤1.8		C05	
83120125	STPT12-12K440V-2PM	IT (1Ph+N); TNS(1Ph+N)	C	230/-; 400/-	440	12.5	50	20	≤1.8	√	C05	

ELV

ELV Extra Low Voltage, also for use in DC Photovoltaic self-consumption / off-grid applications.

Electrical diagrams

A (1P)

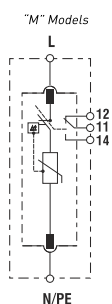

B (N)

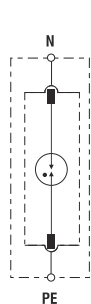

C 2+0 (2P)

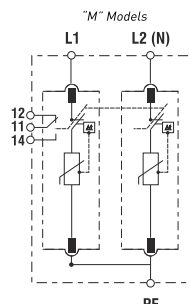

D 1+1 (2PG)

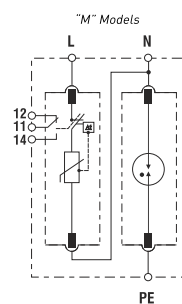

F 2+0 (2P)

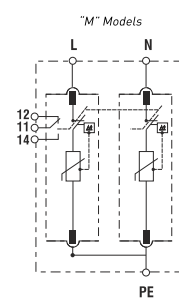

SURGE-TRAP® TYPE 1+2 SPDs | STP T12 12.5

3 poles

REFERENCE NUMBER	CATALOGUE NUMBER	Network									Cartridge Id.	
		SYSTEM TYPE	ELECTRICAL DIAGRAM	Un [Vac]	Uc [V]	Iimp (10/350) [kA]	I _{max} (8/20) [kA]	In (8/20) [kA]	Up@In (8/20) [kV]	REMOTE (M)	L	N
83120128	STPT12-12K150V-3P	TNC (3Ph)	H	-/208	150	12.5	50	20	≤1		C02	-
83120129	STPT12-12K150V-3PM	TNC (3Ph)	H	-/208	150	12.5	50	20	≤1	√	C02	-
83120130	STPT12-12K275V-3P	TNC (3Ph)	H	-/400	275	12.5	50	20	≤1.3		C03	-
83120131	STPT12-12K275V-3PM	TNC (3Ph)	H	-/400	275	12.5	50	20	≤1.3	√	C03	-
83120132	STPT12-12K320V-3P	TNC (3Ph)	H	-/480	320	12.5	50	20	≤1.4		C04	-
83120133	STPT12-12K320V-3PM	TNC (3Ph)	H	-/480	320	12.5	50	20	≤1.4	√	C04	-
83120134	STPT12-12K440V-3P	IT (3Ph); TNC (3Ph)	I; H	-/400; -/690	440	12.5	50	20	≤1.8		C05	-
83120135	STPT12-12K440V-3PM	IT (3Ph); TNC (3Ph)	I; H	-/400; -/690	440	12.5	50	20	≤1.8	√	C05	-

4 poles

REFERENCE NUMBER	CATALOGUE NUMBER	Network									Cartridge Id.	
		SYSTEM TYPE	ELECTRICAL DIAGRAM	Un [Vac]	Uc [V]	Iimp (10/350) [kA]	I _{max} (8/20) [kA]	In (8/20) [kA]	Up@In (8/20) [kV]	REMOTE (M)	L	N
83120136	STPT12-12K150V-4PG	TT (3Ph+N)	J	120/208	150	12.5 (L-N) 50 (N-PE)	50	20	≤1 (L-N) ≤1.5 (N-PE)		C02	C07
83120137	STPT12-12K150V-4PGM	TT (3Ph+N)	J	120/208	150	12.5 (L-N) 50 (N-PE)	50	20	≤1 (L-N) ≤1.5 (N-PE)	√	C02	C07
83120138	STPT12-12K275V-4PG	TT (3Ph+N)	J	230/400	275	12.5 (L-N) 50 (N-PE)	50	20	≤1.3 (L-N) ≤1.5 (N-PE)		C03	C07
83120139	STPT12-12K275V-4PGM	TT (3Ph+N)	J	230/400	275	12.5 (L-N) 50 (N-PE)	50	20	≤1.3 (L-N) ≤1.5 (N-PE)	√	C03	C07
83120140	STPT12-12K320V-4PG	TT (3Ph+N)	J	277/480	320	12.5 (L-N) 50 (N-PE)	50	20	≤1.4 (L-N) ≤1.5 (N-PE)		C04	C07
83120141	STPT12-12K320V-4PGM	TT (3Ph+N)	J	277/480	320	12.5 (L-N) 50 (N-PE)	50	20	≤1.4 (L-N) ≤1.5 (N-PE)	√	C04	C07
83120142	STPT12-12K150V-4P	TNS (3Ph+N)	L	120/208	150	12.5	50	20	≤1		C02	
83120143	STPT12-12K150V-4PM	TNS (3Ph+N)	L	120/208	150	12.5	50	20	≤1	√	C02	
83120144	STPT12-12K275V-4P	TNS (3Ph+N)	L	230/400	275	12.5	50	20	≤1.3		C03	
83120145	STPT12-12K275V-4PM	TNS (3Ph+N)	L	230/400	275	12.5	50	20	≤1.3	√	C03	
83120146	STPT12-12K320V-4P	TNS (3Ph+N)	L	277/480	320	12.5	50	20	≤1.4		C04	
83120147	STPT12-12K320V-4PM	TNS (3Ph+N)	L	277/480	320	12.5	50	20	≤1.4	√	C04	
83120148	STPT12-12K440V-4P	IT (3Ph+N); TNS (3Ph+N)	L	230/400; 400/690	440	12.5	50	20	≤1.8		C05	
83120149	STPT12-12K440V-4PM	IT (3Ph+N); TNS (3Ph+N)	L	230/400; 400/690	440	12.5	50	20	≤1.8	√	C05	

Electrical diagrams

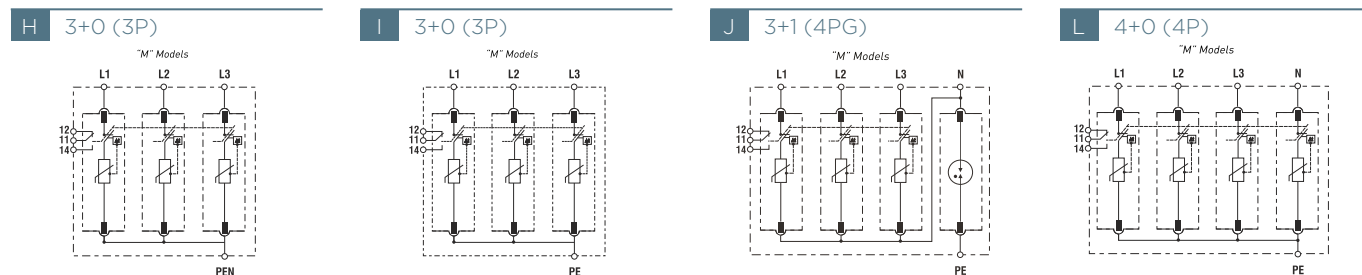

Replacement cartridges

REFERENCE NUMBER	CATALOGUE NUMBER	NETWORK	Un [Vac]	Uc [V]	Iimp (10/350) [kA]	I _{max} (8/20) [kA]	In (8/20) [kA]	Up@In (8/20) [kV]	CARTRIDGE ID.
83120000	SP12-12K75V	L-N (1Ph)	60	75	12.5	50	20	≤0.65	C01
83120001	SP12-12K150V	L-N (1Ph)	120	150	12.5	50	20	≤1	C02
83120002	SP12-12K275V	L-N (1Ph)	230	275	12.5	50	20	≤1.3	C03
83120003	SP12-12K320V	L-N (1Ph)	277	320	12.5	50	20	≤1.4	C04
83120004	SP12-12K440V	L-N (1Ph)	400	440	12.5	50	20	≤1.8	C05
83120005	SP12-25K-N	N-PE (N)	Neutral	255	25	50	25	≤1.5	C06
83120006	SP12-50K-N	N-PE (N)	Neutral	255	50	50	50	≤1.5	C07

SURGE-TRAP® TYPE 1+2 SPDs

STP T12 25

STP T12 25 is the series of combined Type 1+2/Class I+II devices for discharging lightning currents and protecting against voltage surges, in accordance with IEC/EN 61643-11.

Suitable as the first step of protection in incoming power supply panels and areas with exposure to the atmosphere, where installations are usually provided with an external lightning protection system.

Ratings and features

- Lightning impulse current (10/350µs): 25kA per phase
- Maximum discharge current (8/20µs): 100kA per phase
- Nominal discharge current (8/20µs): 25kA per phase
- TNS, TNC and TT networks
- $U_n(L-N/L-L)$: 230/400V
- DIN-rail mountable, plug-in format
- Visual and remote end of life indicators
- Reversible chassis to allow cable entry from above or below
- Mechanically coded cartridges to avoid cartridge replacement errors



GUIDE

Example

STP T12 - 25K 275V - 4PG M

Surge-Trap® Pluggable Type 1+2 / Class I+II combined lightning current arrester (10/350µs) and surge protective device (8/20µs)

Step 1

Lightning impulse current

25K limp (L-N) =25kA
100K limp (N-PE) =100kA

Step 2

Operating voltage

Uc Un (L-N/L-L)
275V 230/400V
Blank N-PE protection

Step 3

Network configuration

1P L-N; 1Ph (TNS, TNC, IT, TT)
2P 2+0; 1Ph+N (TNS, IT)
2PG 1+1; 1Ph+N (TT)
3P 3+0; 3Ph (TNC, IT)
4P 4+0; 3Ph+N (TNS, IT)
4PG 3+1; 3Ph+N (TT)
N N-PE; Neutral (TT Spark-Gap)

Step 4

Remote monitoring

M Microswitch included

Dimensions

1 pole

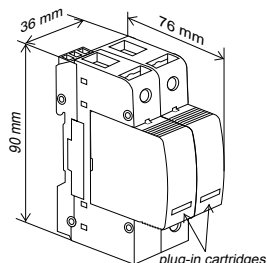

2 poles

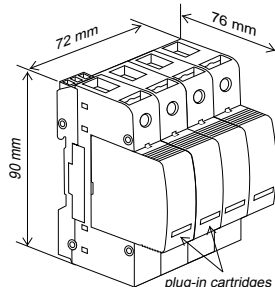

3 poles

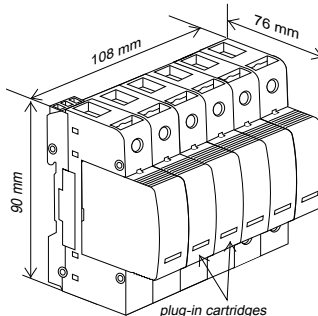

4 poles

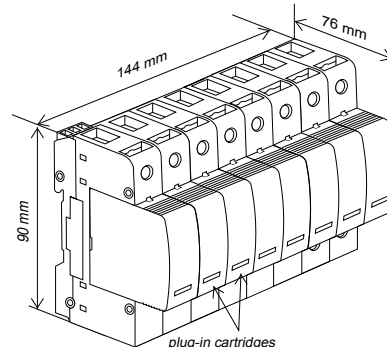

Microswitch diagram

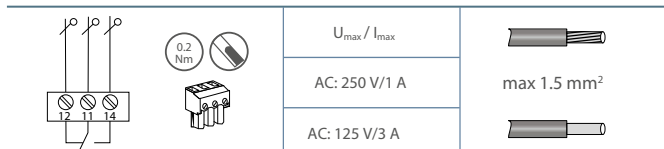

SURGE-TRAP® TYPE 1+2 SPDs | STP T12 25

Catalogue numbers / Reference numbers

1 pole

REFERENCE NUMBER	CATALOGUE NUMBER	Network								Cartridge Id.		
		SYSTEM TYPE	ELECTRICAL DIAGRAM	Un [Vac]	Uc [V]	Iimp (10/350) [kA]	I _{max} (8/20) [kA]	In (8/20) [kA]	Up [kV]	REMOTE (M)	L	N
83120152	STPT12-25K275V-1P	L-N (1Ph)	A	230	275	25	100	25	≤ 1,5		C65	
83120153	STPT12-25K275V-1PM	L-N (1Ph)	A	230	275	25	100	25	≤ 1,5	√	C65	
83120166	STPT12-100K-N	N-PE (N)	B	Neutral	255	100	100	50	≤ 1,5			C66

2 poles

REFERENCE NUMBER	CATALOGUE NUMBER	Network								Cartridge Id.		
		SYSTEM TYPE	ELECTRICAL DIAGRAM	Un [Vac]	Uc [V]	Iimp (10/350) [kA]	I _{max} (8/20) [kA]	In (8/20) [kA]	Up [kV]	REMOTE (M)	L	N
83120156	STPT12-25K275V-2P	TNS (1Ph+N)	C	230 / -	275	25	100	25	≤ 1,5		C65	
83120157	STPT12-25K275V-2PM	TNS (1Ph+N)	C	230 / -	275	25	100	25	≤ 1,5	√	C65	
83120154	STPT12-25K275V-2PG	TT (1Ph+N)	D	230 / -	275	25	100	25	≤ 1,5		C65	C67
83120155	STPT12-25K275V-2PGM	TT (1Ph+N)	D	230 / -	275	25	100	25	≤ 1,5	√	C65	C67

3 poles

REFERENCE NUMBER	CATALOGUE NUMBER	Network								Cartridge Id.		
		SYSTEM TYPE	ELECTRICAL DIAGRAM	Un [Vac]	Uc [V]	Iimp (10/350) [kA]	I _{max} (8/20) [kA]	In (8/20) [kA]	Up [kV]	REMOTE (M)	L	N
83120158	STPT12-25K275V-3P	TNC (3Ph)	E	- / 400	275	25	100	25	≤ 1,5		C65	
83120159	STPT12-25K275V-3PM	TNC (3Ph)	E	- / 400	275	25	100	25	≤ 1,5	√	C65	

4 poles

REFERENCE NUMBER	CATALOGUE NUMBER	Network								Cartridge Id.		
		SYSTEM TYPE	ELECTRICAL DIAGRAM	Un [Vac]	Uc [V]	Iimp (10/350) [kA]	I _{max} (8/20) [kA]	In (8/20) [kA]	Up [kV]	REMOTE (M)	L	N
83120160	STPT12-25K275V-4P	TNS (3Ph+N)	F	230 / 400	275	25	100	25	≤ 1,5		C65	
83120161	STPT12-25K275V-4PM	TNS (3Ph+N)	F	230 / 400	275	25	100	25	≤ 1,5	√	C65	
83120150	STPT12-25K275V-4PG	TT (3Ph+N)	G	230 / 400	275	25	100	25	≤ 1,5		C65	C66
83120151	STPT12-25K275V-4PGM	TT (3Ph+N)	G	230 / 400	275	25	100	25	≤ 1,5	√	C65	C66

Electrical diagrams

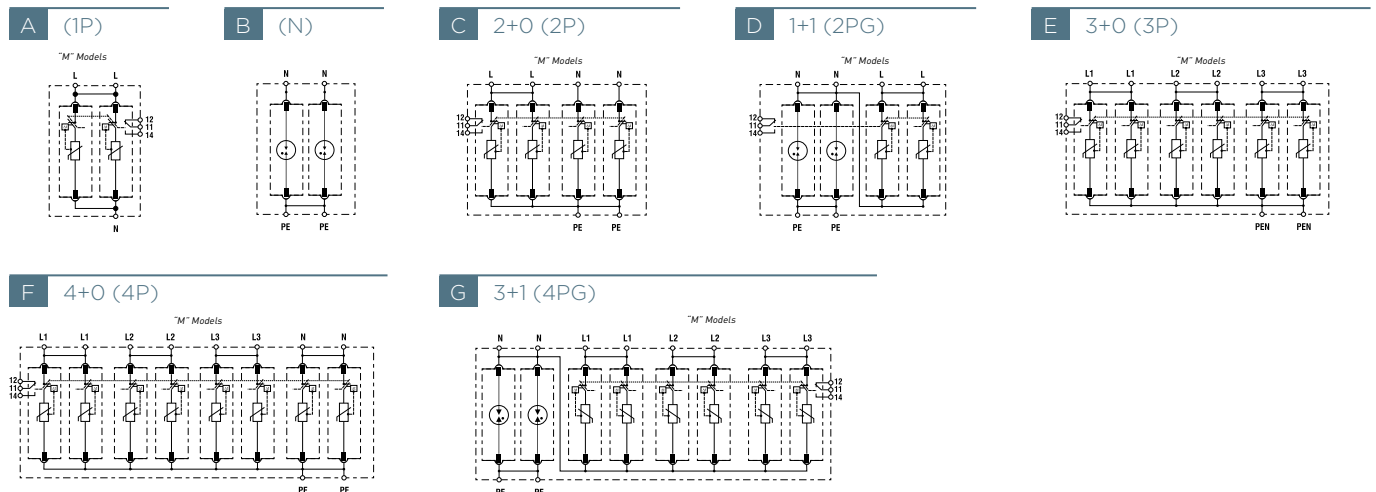

Replacement cartridges

REFERENCE NUMBER	CATALOGUE NUMBER	NETWORK	Un [Vac]	Uc [V]	Iimp (10/350) [kA]	I _{max} (8/20) [kA]	In (8/20) [kA]	Up [kV]	CARTRIDGE ID.
83120007	SP12-25K275V	L-N (1Ph)	230	275	25	100	25	≤ 1,5	C65
83120009	SP12-50K-2PN	N-PE (N)	Neutral	255	50	100	25	≤ 1,5	C66
83120008	SP12-100K-N	N-PE (N)	Neutral	255	100	100	50	≤ 1,5	C67

SURGE-TRAP® TYPE 2 SPDs

STP T2 40

STP T2 40 is the series of Type 2/Class II devices for discharging voltage surges, in accordance with IEC/EN 61643-11.

Suitable for the second stage of protection in supply distribution panels in which Type 1 protection devices are installed upstream, or for the first stage of protection in commercial or other applications not exposed to direct lightning strikes and with no external lightning protection system.

Ratings and features

- Maximum discharge current (8/20µs): 40kA per phase
- Nominal discharge current (8/20µs): 20kA per phase
- TNS, TNC, TT and IT networks
- Un(L-N/L-L): 48V, 60V, 120/208V, 230/400V, 277/480V, 400/690V & higher
- DIN-rail mountable, plug-in format
- Visual and remote end of life indicators
- Reversible chassis to allow cable entry from above or below
- Mechanically coded cartridges to avoid cartridge replacement errors

I_{max} **40kA**

Approvals/Standards

- IEC/EN 61643-11
- CE
- UL 1449 4th Edition

GUIDE

Example

STP T2 - 40K 275V - 4PG M

Surge-Trap® Pluggable Type 2 / Class II surge protective device (8/20µs)

	Step 1	Step 2	Step 3	Step 4																																		
	Max. discharge current	Operating voltage	Network configuration	Remote monitoring																																		
	40K I _{max} (L-N) =40kA 30K I _{max} (L-N) =30kA (for 750V only)	<table style="width: 100%; border-collapse: collapse;"> <tr> <th style="text-align: left; border-bottom: 1px solid black;">U_c</th> <th style="text-align: left; border-bottom: 1px solid black;">U_n (L-N/L-L)</th> </tr> <tr> <td>60V</td> <td>48-/V</td> </tr> <tr> <td>75V</td> <td>60-/V</td> </tr> <tr> <td>150V</td> <td>120/208V</td> </tr> <tr> <td>275V</td> <td>230/400V</td> </tr> <tr> <td>320V</td> <td>277/480V</td> </tr> <tr> <td>440V</td> <td>230/400V "IT"; 400/690V</td> </tr> <tr> <td>750V</td> <td>400/690V; 690/1000V</td> </tr> <tr> <td>Blank</td> <td>N-PE protection</td> </tr> </table>	U _c	U _n (L-N/L-L)	60V	48-/V	75V	60-/V	150V	120/208V	275V	230/400V	320V	277/480V	440V	230/400V "IT"; 400/690V	750V	400/690V; 690/1000V	Blank	N-PE protection	<table style="width: 100%; border-collapse: collapse;"> <tr> <th style="text-align: left; border-bottom: 1px solid black;">1P</th> <th style="text-align: left; border-bottom: 1px solid black;">L-N; 1Ph [TNS,TNC,IT,TT]</th> </tr> <tr> <th style="text-align: left; border-bottom: 1px solid black;">N</th> <th style="text-align: left; border-bottom: 1px solid black;">N-PE; Neutral (TT Spark-Gap)</th> </tr> <tr> <th style="text-align: left; border-bottom: 1px solid black;">2P</th> <th style="text-align: left; border-bottom: 1px solid black;">2+0; 1Ph+N [TNS,IT]</th> </tr> <tr> <th style="text-align: left; border-bottom: 1px solid black;">2PG</th> <th style="text-align: left; border-bottom: 1px solid black;">1+1; 1Ph+N (TT)</th> </tr> <tr> <th style="text-align: left; border-bottom: 1px solid black;">3P</th> <th style="text-align: left; border-bottom: 1px solid black;">3+0; 3Ph [TNC,IT]</th> </tr> <tr> <th style="text-align: left; border-bottom: 1px solid black;">4P</th> <th style="text-align: left; border-bottom: 1px solid black;">4+0; 3Ph+N [TNS,IT]</th> </tr> <tr> <th style="text-align: left; border-bottom: 1px solid black;">4PG</th> <th style="text-align: left; border-bottom: 1px solid black;">3+1; 3Ph+N (TT)</th> </tr> </table>	1P	L-N; 1Ph [TNS,TNC,IT,TT]	N	N-PE; Neutral (TT Spark-Gap)	2P	2+0; 1Ph+N [TNS,IT]	2PG	1+1; 1Ph+N (TT)	3P	3+0; 3Ph [TNC,IT]	4P	4+0; 3Ph+N [TNS,IT]	4PG	3+1; 3Ph+N (TT)	<table style="width: 100%; border-collapse: collapse;"> <tr> <th style="text-align: left; border-bottom: 1px solid black;">M</th> <th style="text-align: left; border-bottom: 1px solid black;">Microswitch included</th> </tr> </table>	M	Microswitch included
U _c	U _n (L-N/L-L)																																					
60V	48-/V																																					
75V	60-/V																																					
150V	120/208V																																					
275V	230/400V																																					
320V	277/480V																																					
440V	230/400V "IT"; 400/690V																																					
750V	400/690V; 690/1000V																																					
Blank	N-PE protection																																					
1P	L-N; 1Ph [TNS,TNC,IT,TT]																																					
N	N-PE; Neutral (TT Spark-Gap)																																					
2P	2+0; 1Ph+N [TNS,IT]																																					
2PG	1+1; 1Ph+N (TT)																																					
3P	3+0; 3Ph [TNC,IT]																																					
4P	4+0; 3Ph+N [TNS,IT]																																					
4PG	3+1; 3Ph+N (TT)																																					
M	Microswitch included																																					

Dimensions

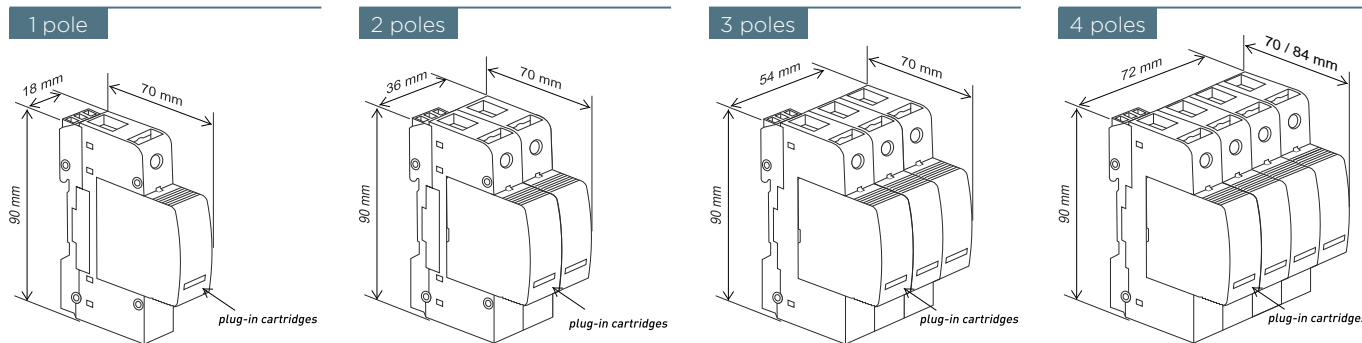

Microswitch diagram

	U _{max} / I _{max}	
	AC: 250 V/1 A	max 1.5 mm ²
	AC: 125 V/3 A	

SURGE-TRAP® TYPE 2 SPDs | STP T2 40

Catalogue numbers / Reference numbers

1 pole

REFERENCE NUMBER	CATALOGUE NUMBER	Network							Cartridge Id.		
		SYSTEM TYPE	ELECTRICAL DIAGRAM	Un [VAC]	Uc [V]	I _{max} (8/20) [KA]	In (8/20) [KA]	Up@In (8/20) [KV]	REMOTE (M)	L	N
83020104	STPT2-40K150V-1P	L-N (1Ph)	A	120	175	40	20	≤1.0		C22	-
83020105	STPT2-40K150V-1PM	L-N (1Ph)	A	120	175	40	20	≤1.0	√	C22	-
83020106	STPT2-40K275V-1P	L-N (1Ph)	A	230	275	40	20	≤1.3		C23	-
83020107	STPT2-40K275V-1PM	L-N (1Ph)	A	230	275	40	20	≤1.3	√	C23	-
83020108	STPT2-40K320V-1P	L-N (1Ph)	A	277	320	40	20	≤1.5		C24	-
83020109	STPT2-40K320V-1PM	L-N (1Ph)	A	277	320	40	20	≤1.5	√	C24	-
83020110	STPT2-40K440V-1P	L-N (1Ph)	A	400	440	40	20	≤2		C25	-
83020111	STPT2-40K440V-1PM	L-N (1Ph)	A	400	440	40	20	≤2	√	C25	-
83020100	STPT2-30K750V-1P	L-N (1Ph)	A	690	750	30	15	≤3		C26	-
83020101	STPT2-30K750V-1PM	L-N (1Ph)	A	690	750	30	15	≤3	√	C26	-
83020112	STPT2-40K-N	N-PE (N)	B	Neutral	265	40	20	≤1.5		-	C27

2 poles

REFERENCE NUMBER	CATALOGUE NUMBER	Network							Cartridge Id.		
		SYSTEM TYPE	ELECTRICAL DIAGRAM	Un [VAC]	Uc [V]	I _{max} (8/20) [KA]	In (8/20) [KA]	Up@In (8/20) [KV]	REMOTE (M)	L	N
83020128	STPT2-40K60V-2P	TNS (1Ph+N); PV	C	48/-	60; 65 Ucpv	40	20	≤0.7		C20	
83020129	STPT2-40K60V-2PM	TNS (1Ph+N); PV	C	48/-	60; 65 Ucpv	40	20	≤0.7	√	C20	
83020130	STPT2-40K75V-2P	TNS (1Ph+N); PV	C	60/-	75; 80 Ucpv	40	20	≤0.8		C21	
83020131	STPT2-40K75V-2PM	TNS (1Ph+N); PV	C	60/-	75; 80 Ucpv	40	20	≤0.8	√	C21	
83020114	STPT2-40K150V-2PG	TT (1Ph+N)	D	120/-	175	40	20	≤1.0 (L-N) ≤1.5 (N-PE)		C22	C27
83020115	STPT2-40K150V-2PGM	TT (1Ph+N)	D	120/-	175	40	20	≤1.0 (L-N) ≤1.5 (N-PE)	√	C22	C27
83020116	STPT2-40K275V-2PG	TT (1Ph+N)	D	230/-	275	40	20	≤1.3 (L-N) ≤1.5 (N-PE)		C23	C27
83020117	STPT2-40K275V-2PGM	TT (1Ph+N)	D	230/-	275	40	20	≤1.3 (L-N) ≤1.5 (N-PE)	√	C23	C27
83020118	STPT2-40K320V-2PG	TT (1Ph+N)	D	277/-	320	40	20	≤1.5 (L-N) ≤1.5 (N-PE)		C24	C27
83020119	STPT2-40K320V-2PGM	TT (1Ph+N)	D	277/-	320	40	20	≤1.5 (L-N) ≤1.5 (N-PE)	√	C24	C27
83020120	STPT2-40K150V-2P	TNS (1Ph+N)	F	120/-	175	40	20	≤1.0		C22	
83020121	STPT2-40K150V-2PM	TNS (1Ph+N)	F	120/-	175	40	20	≤1.0	√	C22	
83020122	STPT2-40K275V-2P	TNS (1Ph+N)	F	230/-	275	40	20	≤1.3		C23	
83020123	STPT2-40K275V-2PM	TNS (1Ph+N)	F	230/-	275	40	20	≤1.3	√	C23	
83020124	STPT2-40K320V-2P	TNS (1Ph+N)	F	277/-	320	40	20	≤1.5		C24	
83020125	STPT2-40K320V-2PM	TNS (1Ph+N)	F	277/-	320	40	20	≤1.5	√	C24	
83020126	STPT2-40K440V-2P	IT (1Ph+N); TNS(1Ph+N)	C	230/-; 400/-	440	40	20	≤2		C25	
83020127	STPT2-40K440V-2PM	IT (1Ph+N); TNS(1Ph+N)	C	230/-; 400/-	440	40	20	≤2	√	C25	

ELV

ELV Extra Low Voltage, also for use in DC Photovoltaic self-consumption / off-grid applications.

Electrical diagrams

A (1P)

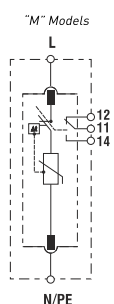

B (N)

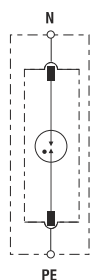

C 2+0 (2P)

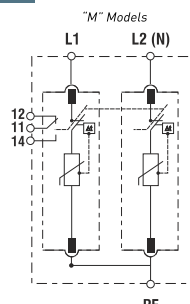

D 1+1 (2PG)

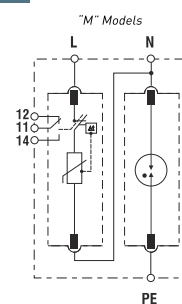

F 2+0 (2P)

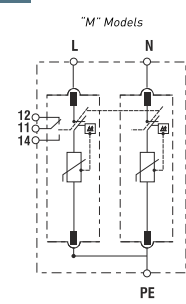

SURGE-TRAP® TYPE 2 SPDs | STP T2 40

3 poles

REFERENCE NUMBER	CATALOGUE NUMBER	Network							Cartridge Id.		
		SYSTEM TYPE	ELECTRICAL DIAGRAM	Un [VAC]	Uc [V]	I _{max} (8/20) [KA]	In (8/20) [KA]	Up@In (8/20) [KV]	REMOTE (M)	L	N
83020132	STPT2-40K150V-3P	TNC (3Ph)	H	-/208	175	40	20	≤1.0		C22	-
83020133	STPT2-40K150V-3PM	TNC (3Ph)	H	-/208	175	40	20	≤1.0	√	C22	-
83020134	STPT2-40K275V-3P	TNC (3Ph)	H	-/400	275	40	20	≤1.3		C23	-
83020135	STPT2-40K275V-3PM	TNC (3Ph)	H	-/400	275	40	20	≤1.3	√	C23	-
83020136	STPT2-40K320V-3P	TNC (3Ph)	H	-/480	320	40	20	≤1.5		C24	-
83020137	STPT2-40K320V-3PM	TNC (3Ph)	H	-/480	320	40	20	≤1.5	√	C24	-
83020142	STPT2-40K440V-3P	IT (3Ph); TNC (3Ph)	I	-/400; -/690	440	40	20	≤2		C25	-
83020143	STPT2-40K440V-3PM	IT (3Ph); TNC (3Ph)	I	-/400; -/690	440	40	20	≤2	√	C25	-
83020102	STPT2-30K750V-3P	TNC (3Ph)	H	-/690; -/1000	750	30	15	≤3		C26	-
83020103	STPT2-30K750V-3PM	TNC (3Ph)	H	-/690; -/1000	750	30	15	≤3	√	C26	-

4 poles

REFERENCE NUMBER	CATALOGUE NUMBER	Network							Cartridge Id.		
		SYSTEM TYPE	ELECTRICAL DIAGRAM	Un [VAC]	Uc [V]	I _{max} (8/20) [KA]	In (8/20) [KA]	Up@In (8/20) [KV]	REMOTE (M)	L	N
83020144	STPT2-40K150V-4PG	TT (3Ph+N)	J	120/208	175	40	20	≤1.0 (L-N) ≤1.5 (N-PE)		C22	C27
83020145	STPT2-40K150V-4PGM	TT (3Ph+N)	J	120/208	175	40	20	≤1.0 (L-N) ≤1.5 (N-PE)	√	C22	C27
83020146	STPT2-40K275V-4PG	TT (3Ph+N)	J	230/400	275	40	20	≤1.3 (L-N) ≤1.5 (N-PE)		C23	C27
83020147	STPT2-40K275V-4PGM	TT (3Ph+N)	J	230/400	275	40	20	≤1.3 (L-N) ≤1.5 (N-PE)	√	C23	C27
83020148	STPT2-40K320V-4PG	TT (3Ph+N)	J	277/480	320	40	20	≤1.5 (L-N) ≤1.5 (N-PE)		C24	C27
83020149	STPT2-40K320V-4PGM	TT (3Ph+N)	J	277/480	320	40	20	≤1.5 (L-N) ≤1.5 (N-PE)	√	C24	C27
83020150	STPT2-40K150V-4P	TNS (3Ph+N)	L	120/208	175	40	20	≤1.0		C22	
83020151	STPT2-40K150V-4PM	TNS (3Ph+N)	L	120/208	175	40	20	≤1.0	√	C22	
83020152	STPT2-40K275V-4P	TNS (3Ph+N)	L	230/400	275	40	20	≤1.3		C23	
83020153	STPT2-40K275V-4PM	TNS (3Ph+N)	L	230/400	275	40	20	≤1.3	√	C23	
83020154	STPT2-40K320V-4P	TNS (3Ph+N)	L	277/480	320	40	20	≤1.5		C24	
83020155	STPT2-40K320V-4PM	TNS (3Ph+N)	L	277/480	320	40	20	≤1.5	√	C24	
83020156	STPT2-40K440V-4P	IT (3Ph+N); TNS (3Ph+N)	L	230/400; 400/690	440	40	20	≤2		C25	
83020157	STPT2-40K440V-4PM	IT (3Ph+N); TNS (3Ph+N)	L	230/400; 400/690	440	40	20	≤2	√	C25	

Electrical diagrams

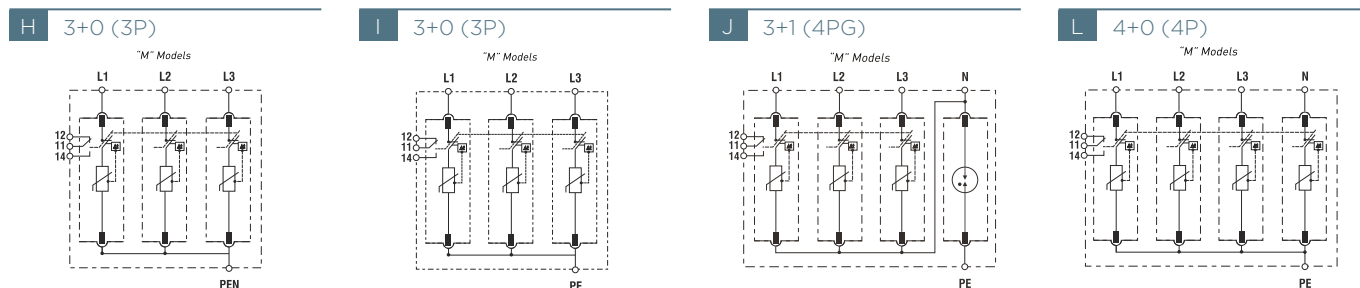

Replacement cartridges

REFERENCE NUMBER	CATALOGUE NUMBER	NETWORK	Un [VAC]	Uc [V]	I _{max} (8/20) [KA]	In (8/20) [KA]	Up@In (8/20) [KV]	CARTRIDGE ID.
83020008	SP2-40K60V	L-N (1Ph)	48	60	40	20	≤0.7	C20
83020009	SP2-40K75V	L-N (1Ph)	60	75	40	20	≤0.8	C21
83020001	SP2-40K150V	L-N (1Ph)	120	175	40	20	≤1.0	C22
83020002	SP2-40K275V	L-N (1Ph)	230	275	40	20	≤1.3	C23
83020003	SP2-40K320V	L-N (1Ph)	277	320	40	20	≤1.5	C24
83020004	SP2-40K440V	L-N (1Ph)	400	440	40	20	≤2	C25
83020007	SP2-30K750V	L-N (1Ph)	690	750	30	15	≤3	C26
83020000	SP2-40K-N	N-PE (N)	Neutral	265	40	20	≤1.5	C27

SURGE-TRAP® TYPE 2+3 SPDs

STP T23 20

STP T23 20 is the series of combined Type 2+3/Class II+III devices for discharging voltage surges while providing a very fine voltage protection level, in accordance with IEC/EN 61643-11.

Suitable as the final stage of protection in panels with Type 2 protection devices installed upstream such as STP T2 40 SPDs. These SPDs should be installed as close as possible to the equipment being protected.

Ratings and features

- Maximum discharge current (8/20µs): 20kA per phase
- Nominal discharge current (8/20µs): 10kA per phase
- Combined voltage pulse Uoc (1.2/50µs): 10kV
- TNS, TNC, TT and IT networks
- Un(L-N/L-L): 120/208V, 230/400V, 277/480V and 400/690V
- PLC friendly solutions (LCF) for Power Line Communications
- DIN-rail mountable, plug-in format
- Visual and remote end of life indicators
- Reversible chassis to allow cable entry from above or below
- Mechanically coded cartridges to avoid cartridge replacement errors

Imax

20kA



Approvals/Standards

- IEC/EN 61643-11
- CE



GUIDE

Example

STP T23 - 20K 275V - 4PG LF M

Surge-Trap® Pluggable Type 2+3 / Class II+III surge protective device (8/20µs) and very fine protection of equipment (1.2/50µs)

Step 1	Step 2	Step 3	Step 4	Step 5
Max. discharge current	Operating voltage	Network configuration	Additional features	Remote monitoring
20K I _{max} (L-N) =20kA	Uc Un (L-N/L-L)	1P L-N; 1Ph (TNS,TNC,IT,TT) N N-PE; Neutral (TT Spark-Gap)	LF Leakage current free	M Microswitch included
	150V 120/208V 275V 230/400V (for LF models only) 320V 230/400V; 277/480V 440V 230/400V "IT" 400/690V	2P 2+0; 1Ph+N (TNS) 2PG 1+1; 1Ph+N (TT) 3P 3+0; 3Ph (TNC) 4P 4+0; 3Ph+N (TNS) 4PG 3+1; 3Ph+N (TT)		
	Blank N-PE protection			

Dimensions

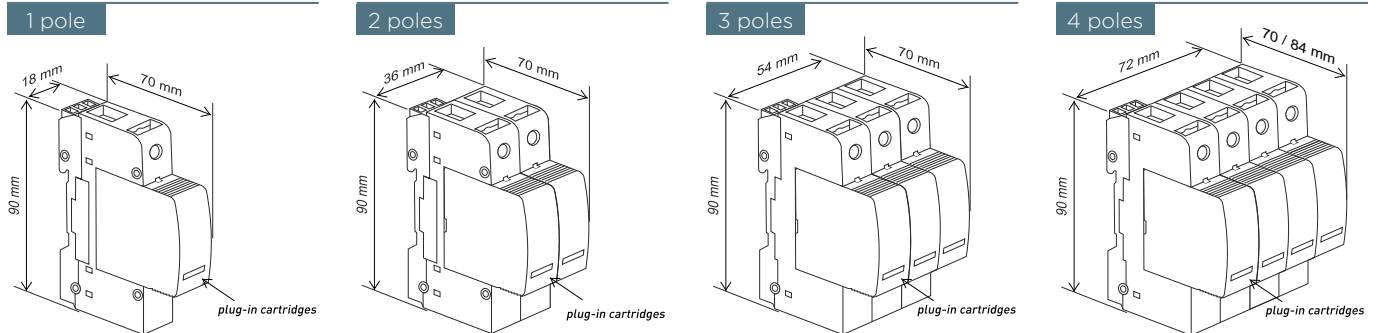

Microswitch diagram

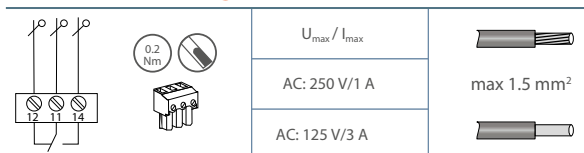

SURGE-TRAP® TYPE 2+3 SPDs | STP T23 20

Catalogue numbers / Reference numbers

1 pole

REFERENCE NUMBER	CATALOGUE NUMBER	Network		Un [Vac]	Uc [V]	Imax (8/20) [kA]	In (8/20) [kA]	Uoc [kV]	Up@In (8/20) [kV]	REMOTE (M)	Cartridge Id.	
		SYSTEM TYPE	ELECTRICAL DIAGRAM								L	N
83230100	STPT23-20K150V-1P	L-N (1Ph)	A	120	150	20	10	10	≤0.8		C60	-
83230101	STPT23-20K150V-1PM	L-N (1Ph)	A	120	150	20	10	10	≤0.8	√	C60	-
83230102	STPT23-20K320V-1P	L-N (1Ph)	A	230; 277	320	20	10	10	≤1.4		C62	-
83230103	STPT23-20K320V-1PM	L-N (1Ph)	A	230; 277	320	20	10	10	≤1.4	√	C62	-
83230104	STPT23-20K440V-1P	L-N (1Ph)	A	400	440	20	10	10	≤2		C63	-
83230105	STPT23-20K440V-1PM	L-N (1Ph)	A	400	440	20	10	10	≤2	√	C63	-
83230106	STPT23-20K-N	N-PE (N)	B	Neutral	255	20	10	10	≤1.5		-	C64

2 poles

REFERENCE NUMBER	CATALOGUE NUMBER	Network		Un [Vac]	Uc [V]	Imax (8/20) [kA]	In (8/20) [kA]	Uoc [kV]	Up@In(8/20) [kV]	REMOTE (M)	Cartridge Id.	
		SYSTEM TYPE	ELECTRICAL DIAGRAM								L	N
83230108	STPT23-20K150V-2PG	TT (1Ph+N)	D	120/-	150	20	10	10	≤0.8 (L-N) ≤1.5 (N-PE)		C60	C64
83230109	STPT23-20K150V-2PGM	TT (1Ph+N)	D	120/-	150	20	10	10	≤0.8 (L-N) ≤1.5 (N-PE)	√	C60	C64
83230112	STPT23-20K320V-2PG	TT (1Ph+N)	D	230/-; 277/-	320	20	10	10	≤1.4 (L-N) ≤1.5 (N-PE)		C62	C64
83230113	STPT23-20K320V-2PGM	TT (1Ph+N)	D	230/-; 277/-	320	20	10	10	≤1.4 (L-N) ≤1.5 (N-PE)	√	C62	C64
83230110	STPT23-20K275V-2PG-LF	TT (1Ph+N)	E	230/-	275	20	10	10	≤1.5 (L-N) ≤1.5 (N-PE)		C61	C64
83230111	STPT23-20K275V-2PG-LFM	TT (1Ph+N)	E	230/-	275	20	10	10	≤1.5 (L-N) ≤1.5 (N-PE)	√	C61	C64
83230114	STPT23-20K150V-2P	TNS (1Ph+N)	F	120/-	150	20	10	10	≤0.8			C60
83230115	STPT23-20K150V-2PM	TNS (1Ph+N)	F	120/-	150	20	10	10	≤0.8	√		C60
83230116	STPT23-20K320V-2P	TNS (1Ph+N)	F	230/-; 277/-	320	20	10	10	≤1.4			C62
83230117	STPT23-20K320V-2PM	TNS (1Ph+N)	F	230/-; 277/-	320	20	10	10	≤1.4	√		C62
83230134	STPT23-20K275V-2P-LF	TNS (1Ph+N)	G	230/-	275	20	10	10	≤1.5			C61
83230135	STPT23-20K275V-2P-LFM	TNS (1Ph+N)	G	230/-	275	20	10	10	≤1.5	√		C61

3 poles

REFERENCE NUMBER	CATALOGUE NUMBER	Network		Un [Vac]	Uc [V]	Imax (8/20) [kA]	In (8/20) [kA]	Uoc [kV]	Up@In (8/20) [kV]	REMOTE (M)	Cartridge Id.	
		SYSTEM TYPE	ELECTRICAL DIAGRAM								L	N
83230118	STPT23-20K150V-3P	TNC (3Ph)	H	-/208	150	20	10	10	≤0.8		C60	-
83230119	STPT23-20K150V-3PM	TNC (3Ph)	H	-/208	150	20	10	10	≤0.8	√	C60	-
83230122	STPT23-20K320V-3P	TNC (3Ph)	H	-/400; -/480	320	20	10	10	≤1.4		C62	-
83230123	STPT23-20K320V-3PM	TNC (3Ph)	H	-/400; -/480	320	20	10	10	≤1.4	√	C62	-
83230120	STPT23-20K275V-3P-LF	TNC (3Ph)	N	-/400	275	20	10	10	≤1.5		C61	-
83230121	STPT23-20K275V-3P-LFM	TNC (3Ph)	N	-/400	275	20	10	10	≤1.5	√	C61	-

4 poles

REFERENCE NUMBER	CATALOGUE NUMBER	Network		Un [Vac]	Uc [V]	Imax (8/20) [kA]	In (8/20) [kA]	Uoc [kV]	Up@In(8/20) [kV]	REMOTE (M)	Cartridge Id.	
		SYSTEM TYPE	ELECTRICAL DIAGRAM								L	N
83230124	STPT23-20K150V-4PG	TT (3Ph+N)	J	120/208	150	20	10	10	≤0.8 (L-N) ≤1.5 (N-PE)		C60	C64
83230125	STPT23-20K150V-4PGM	TT (3Ph+N)	J	120/208	150	20	10	10	≤0.8 (L-N) ≤1.5 (N-PE)	√	C60	C64
83230128	STPT23-20K320V-4PG	TT (3Ph+N)	J	230/400; 277/480	320	20	10	10	≤1.4 (L-N) ≤1.5 (N-PE)		C62	C64
83230129	STPT23-20K320V-4PGM	TT (3Ph+N)	J	230/400; 277/480	320	20	10	10	≤1.4 (L-N) ≤1.5 (N-PE)	√	C62	C64
83230126	STPT23-20K275V-4PG-LF	TT (3Ph+N)	K	230/400	275	20	10	10	≤1.5 (L-N) ≤1.5 (N-PE)		C61	C64
83230127	STPT23-20K275V-4PG-LFM	TT (3Ph+N)	K	230/400	275	20	10	10	≤1.5 (L-N) ≤1.5 (N-PE)	√	C61	C64
83230130	STPT23-20K150V-4P	TNS (3Ph+N)	L	120/208	150	20	10	10	≤0.8			C60
83230131	STPT23-20K150V-4PM	TNS (3Ph+N)	L	120/208	150	20	10	10	≤0.8	√		C60
83230132	STPT23-20K320V-4P	TNS (3Ph+N)	L	230/400; 277/480	320	20	10	10	≤1.4			C62
83230133	STPT23-20K320V-4PM	TNS (3Ph+N)	L	230/400; 277/480	320	20	10	10	≤1.4	√		C62
83230136	STPT23-20K275V-4P-LF	TNS (3Ph+N)	M	230/400	275	20	10	10	≤1.5			C61
83230137	STPT23-20K275V-4P-LFM	TNS (3Ph+N)	M	230/400	275	20	10	10	≤1.5	√		C61

SURGE-TRAP® TYPE 2+3 SPDs | STP T23 20

Replacement cartridges

REFERENCE NUMBER	CATALOGUE NUMBER	NETWORK	Un [Vac]	Uc [V]	I _{max} (8/20) [kA]	I _n (8/20) [kA]	U _{oc} [kV]	U _{p@I_n} (8/20) [kV]	CARTRIDGE ID.
83230001	SP23-20K150V	L-N (1Ph)	120	150	20	10	10	≤0.8	C60
83230003	SP23-20K275V-LF	L-N (1Ph)	230	275	20	10	10	≤1.5	C61
83230002	SP23-20K320V	L-N (1Ph)	230; 277	320	20	10	10	≤1.4	C62
83230004	SP23-20K440V	L-N (1Ph)	400	440	20	10	10	≤2	C63
83230000	SP23-20K-N	N-PE (N)	Neutral	255	20	10	10	≤1.5	C64

Electrical diagrams

A (1P)

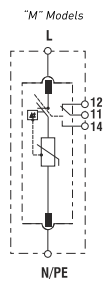

B (N)

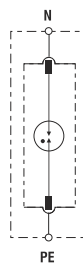

D 1+1 (2PG)

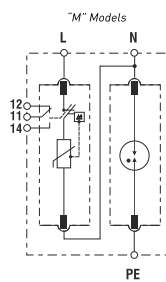

E 1+1 (2PG) LF

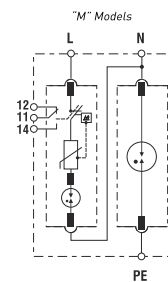

F 2+0 (2P)

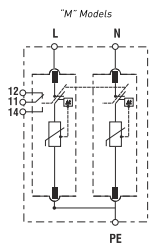

G 2+0 (2P) LF

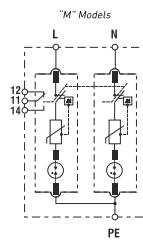

H 3+0 (3P)

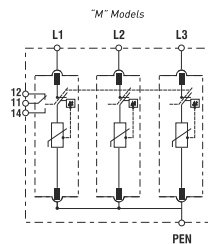

N 3+0 (3P) LF

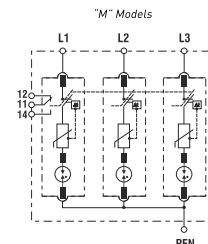

J 3+1 (4PG)

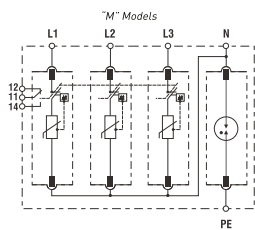

K 3+1 (4PG) LF

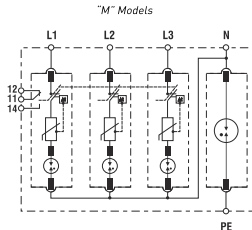

L 4+0 (4P)

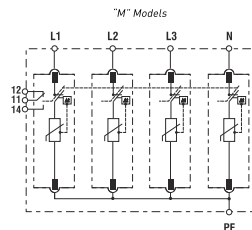

M 4+0 (4P) LF

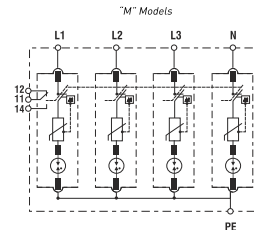

SURGE-TRAP® TYPE 2+3 SPDs

STM T23 20 S

STM T23 20 S is the series of combined Type 2+3/Class II+III devices for discharging voltage surges while providing a very fine voltage protection level, in accordance with IEC/EN 61643-11.

Suitable as the final stage of protection in locations with Type 2 protection devices installed upstream. These SPDs should be installed as close as possible to the equipment being protected. Ideal for limited spaces. Wide range of voltage ratings.

Ratings and features

- Maximum discharge current (8/20µs): 20kA, 6kA
- Nominal discharge current (8/20µs): 10kA, 3kA
- Combined voltage pulse (1.2/50µs): 10kV, 6kV
- Single phase TT and TNS networks
- Un: 12V, 24V, 48V, 60V, 120V, 230V
- Typically for use also in the corresponding DC voltages
- DIN-rail mountable, monobloc format
- Visual (LED) and remote end of life indicators
- Power status (LED) indicator
- Space saving "slim" format



GUIDE

Example

STM T23 - 20K 275V - SP - S M

Surge-Trap®

Type 2+3 / Class II+III surge protective device (8/20µs) and very fine protection of equipment (1.2/50µs)

Step 1	Step 2	Step 3	Step 4	Step 5
Max. discharge current	Operating voltage	Network configuration	Additional features	Remote monitoring
6K I _{max} (L-N) =6kA 20K I _{max} (L-N) =20kA	Uc Un (L-N) 20V 12V 30V 24V 60V 48V 75V 60V 150V 120V 275V 230V	SP Single Phase; 1Ph+N (TT,TNS)	S Slim - space saving	M Microswitch included

Catalogue numbers / Reference numbers

2 poles

REF. NUMBER	CATALOGUE NUMBER WITHOUT REMOTE MONIT.	CATALOGUE NUMBER WITH REMOTE MONIT.	Network							Up@In (8/20) [kV]
			SYSTEM TYPE	ELECTRICAL DIAGRAM	Un [Vac]	Uc [V]	I _{max} (8/20) [kA]	In (8/20) [kA]	Uoc [kV]	
83230500 83230501	STMT23-6K20V-SP-S	STMT23-6K20V-SP-SM	TT/TNS (1Ph+N)	A	12	20	6	3	6	≤0.22 (L1-L2) 0.7 (L1/L2-PE)
83230504 83230505	STMT23-6K30V-SP-S	STMT23-6K30V-SP-SM	TT/TNS (1Ph+N)	A	24	30	6	3	6	≤0.22 (L1-L2) 0.7 (L1/L2-PE)
83230506 83230507	STMT23-6K60V-SP-S	STMT23-6K60V-SP-SM	TT/TNS (1Ph+N)	A	48	60	6	3	6	≤0.33 (L1-L2) 0.7 (L1/L2-PE)
83230508 83230509	STMT23-6K75V-SP-S	STMT23-6K75V-SP-SM	TT/TNS (1Ph+N)	A	60	75	6	3	6	≤0.5 (L1-L2) 0.9 (L1/L2-PE)
83230502 83230503	STMT23-6K150V-SP-S	STMT23-6K150V-SP-SM	TT/TNS (1Ph+N)	A	120	150	6	3	6	≤0.7 (L1-L2) 0.9 (L1/L2-PE)
83230510 83230511	STMT23-20K275V-SP-S	STMT23-20K275V-SP-SM	TT/TNS (1Ph+N)	A	230	275	20	10	10	≤1.4 (L1-L2) 1.4 (L1/L2-PE)

Dimensions

2 poles

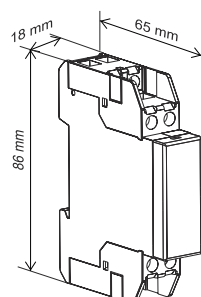

Electrical diagram

A

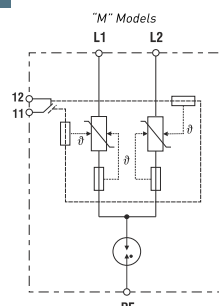

Microswitch diagram

	0.70 Nm	U_{max} / I_{max}
11 12		AC: 250 V/1 A
		DC: 125 V/0.2 A

SURGE-TRAP® TYPE 2+3 SPDs

STE T23 20

STE T23 20 is the series of combined Type 2+3/Class II+III devices for discharging voltage surges while providing a very fine voltage protection level, in accordance with IEC/EN 61643-11. Complete with a built-in powerful EMI filter.

Suitable as the final stage of protection in installations with electromagnetic disturbances which might interrupt, degrade or limit system performance.

Series connection for applications up to 20A rated current.

Ratings and features

- Maximum discharge current (8/20µs): 20kA
- Nominal discharge current (8/20µs): 10kA
- Combined voltage pulse (1.2/50µs): 6kV
- Filter attenuation up to 82dB (common mode)
- Rated current load (IL): 20A
- Single phase TT and TNS networks
- Un: 120V, 230V
- DIN-rail mountable, monobloc format
- Visual (LED) and remote end of life indicators
- Power status (LED) indicator



GUIDE

Example

STE T23 - 20K 275V - SP M

Surge-Trap® Type 2+3 / Class II+III surge protective device (8/20µs) and very fine protection of equipment (1.2/50µs). With EMI filter

Step 1	Step 2	Step 3	Step 4
Max. discharge current	Operating voltage	Network configuration	Remote monitoring
20K Imax (L-N) =20kA	Uc Un (L-N) 150V 120V 275V 230V	SP Single Phase; 1Ph+N (TT,TNS)	M Microswitch included

Catalogue numbers / Reference numbers

2 poles

REFERENCE NUMBER	CATALOGUE NUMBER	Network		Un [Vac]	Uc [V]	Imax (8/20) [kA]	In (8/20) [kA]	Uoc [kV]	Up@In [kV]	IL [A]	REMOTE (M)
		SYSTEM TYPE	ELECTRICAL DIAGRAM								
83230401	STET23-20K150V-SPM	TT/TNS (1Ph+N)	A	120	150	20	10	6	≤0.8	20	✓
83230403	STET23-20K275V-SPM	TT/TNS (1Ph+N)	A	230	275	20	10	6	≤1.2	20	✓

Dimensions

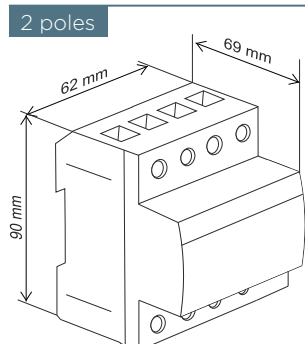

Electrical diagram

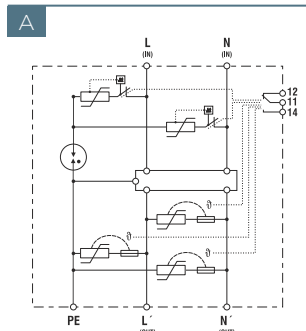

Microswitch diagram

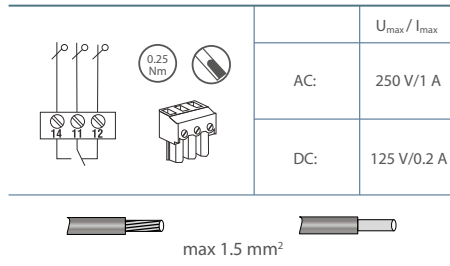

LIGHTNING AND SURGE PROTECTION



PHOTOVOLTAIC SYSTEMS



- SURGE-TRAP[®] HIGHLIGHTS 36
- SURGE-TRAP[®] DC TYPE 1+2 YPV PHOTOVOLTAIC SPD 38
- SURGE-TRAP[®] DC TYPE 2 YPV PHOTOVOLTAIC SPD 39
- SURGE-TRAP[®] DC T2 & T1+2 MPPT PHOTOVOLTAIC SPD 40
- SURGE-TRAP[®] SPD PV BOXES FOR INVERTERS 41
- SURGE-TRAP[®] PCB PLUG-IN OR DIRECT ASSEMBLY 42
- SURGE-TRAP[®] AC TYPE 1+2 PHOTOVOLTAIC SPD 44
- SURGE-TRAP[®] AC TYPE 2 PHOTOVOLTAIC SPD 46
- SURGE-TRAP[®] AC TYPE 2 REINFORCED PEAK WITHSTAND PHOTOVOLTAIC SPD 47

SURGE-TRAP® HIGHLIGHTS

STP Surge-Trap® DC side

See page 13-25

**1500VDC
READY**



UL 1449 4th Ed
EN-50539-11
IEC/EN 61643-31
ROHS



Tested and certified

Mersen's highly specialised test labs for PV product development

Ucpv [Vdc]
65
80
660
720
1060
1500

Wide voltage range

Ucpv up to 1500Vdc



PV: No back-up fuse required

Mersen has developed an optimised dynamic thermal disconnection system, which does not require back-up fuse



PV & Energy Storage System: GBAT fuses

The range of devices for photovoltaics withstands 50kA short-circuit current with 125A GBAT fuses



Type 1+2 and Type 2

SPDs to EN 50539-11
IEC/EN 61643-31

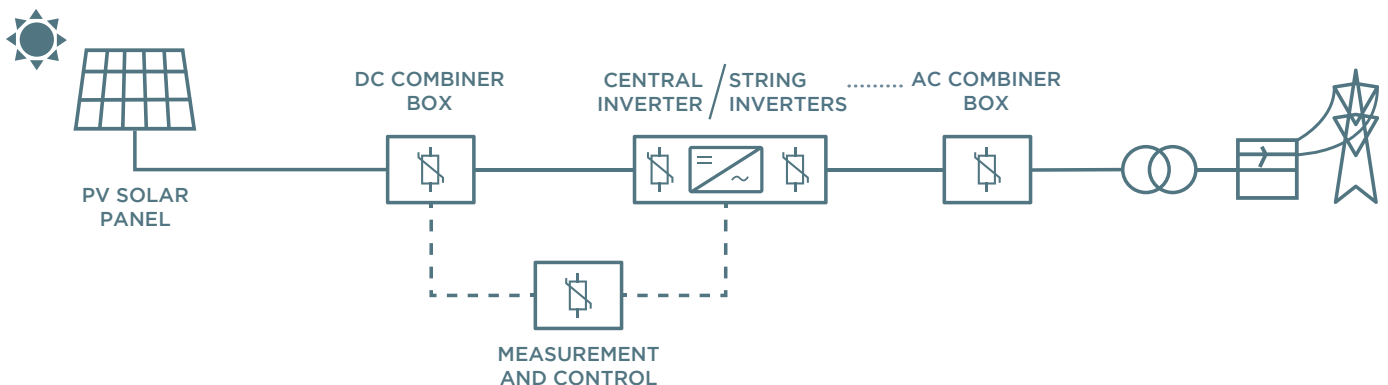

THE BEST PERFORMANCE IN THE MARKET

PV BOX

See page 41

DC junction boxes for inverters to IEC/EN standard

Available in several configurations

- Type 1+2 (5kA Iimp) or Type 2 (40kA I_{max}) SPDs
- MC4 or cable gland connectors
- 1 or 2 MPPT versions

Ready for installation



MPPT

See page 40

Suitable for all PV applications

- Large-scale and rooftop
- Includes specific multipole products for multiple maximum power point tracker (MPPT) inverters



No back-up fuse required



PCB

See page 42

Integration of replaceable surge protection modules on PCBs

Cost & space efficiency

- No wiring wave soldered surge protection
- Space saving solution

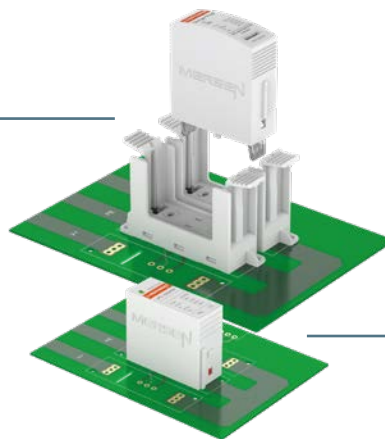

Optimal voltage protection level

Integration at early stage of PCB development

- Close to sensitive electronics
- No cable lengths

Light version

- Small footprint, socket-free assembly (direct PCB mounting)
- 10kA I_n and 25kA I_{max} Type 2 IEC/UL up to 1500 Vdc

AC Side

See page 47

AC reinforced SPDs

- For peak voltage withstand **up to 2,2kV** between L-PE
- Can cope with recurrent generation voltage-peaks in certain situations at **up to 800Vac**

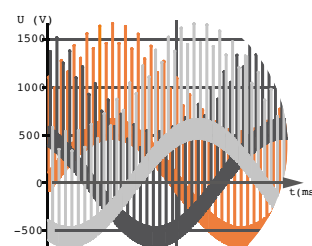

Voltage to ground L-PE

SURGE-TRAP® DC TYPE 1+2 YPV PHOTOVOLTAIC SPD

STP T12 5 YPV

STP T12 5 YPV is the PHOTOVOLTAIC range of combined Type 1+2/Class I+II devices intended for discharging lightning currents (10/350 μ s) and protecting against induced voltage surges (8/20 μ s), in accordance with EN 50539-11 and IEC/EN 61643-31 standards.

Mersen uses a dynamic thermal disconnection system with high breaking capacity, optimised for DC voltages. This means there is no need to install a backup fuse to interrupt the typical short-circuit currents of any photovoltaic installation.

These lightning current and surge protection devices are suitable for all photovoltaic applications: large-scale, rooftop and self-consumption (off-grid) DC installations; especially in facilities provided with external LPS.

Ratings and features

- Lightning impulse current (10/350 μ s): 5 kA
- Maximum discharge current (8/20 μ s): 40 kA
- Nominal discharge current (8/20 μ s): 20 kA
- Ucpv: 1060 Vdc and 1500 Vdc
- Iscpv: 10 kA (EN 50539-11), no back-up fuse required
- Plug-in DIN rail format
- Visual and remote end of life indication
- Reversible chassis to allow cable entry from above or below
- Mechanically coded cartridges to avoid replacement errors

limp

5kA



No back-up fuse required

Approvals/Standards

- EN 50539-11
- IEC/EN 61643-31
- UL 1449 4th Ed recognized, File No. E468946
- CE



Catalogue numbers / Reference numbers

REFERENCE NUMBER	CATALOGUE NUMBER	Network									Cartridge Id.
		SYSTEM TYPE	ELECTRICAL DIAGRAM	UCPV [VDC]	ISCPV [A]	IIMP (10/350) [KA]	IMAX (8/20) [KA]	IN (8/20) [KA]	UP@IN (8/20) [KV]	REMOTE INDICATION (M)	
83120167	STPT12-5K1000V-YPV	"Y" PV	A	1060	10 000	5	40	20	≤ 4		C43
83120168	STPT12-5K1000V-YPVM	"Y" PV	A	1060	10 000	5	40	20	≤ 4	✓	C43
83120193	STPT12-5K1500V-YPV	"Y" PV	A	1500	10 000	5	40	20	≤ 5		C44
83120194	STPT12-5K1500V-YPVM	"Y" PV	A	1500	10 000	5	40	20	≤ 5	✓	C44

Replacement cartridges

REF. NUMBER	CATALOGUE NUMBER	NETWORK	UCPV [VDC]	IIMP (10/350) [KA]	IMAX (8/20) [KA]	IN (8/20) @UP [KA]	UP@IN (8/20) [KV]	CARTRIDGE ID.
83120011	SP12-5K1000V-PV	PV	530	5	40	20	≤ 2	C43
83120023	SP12-5K1500V-PV	PV	750	5	40	20	≤ 2,5	C44

Dimensions

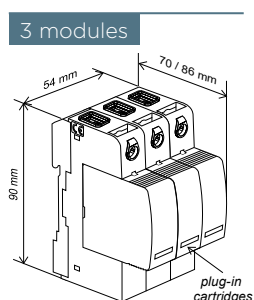

Electrical diagram

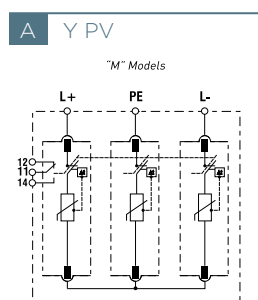

Microswitch diagram

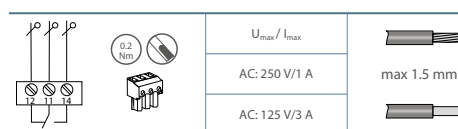

SURGE-TRAP® DC TYPE 2 YPV PHOTOVOLTAIC SPD

STP T2 40 YPV

STP T2 40 YPV is the series of Type 2/Class II devices for discharging voltage surges in PV systems. This series provides advanced overvoltage protection by utilising Mersen's optimised dynamic thermal disconnection system. This system does not require additional overcurrent protection (back-up fuse) due to its high short-circuit withstand rating.

Ratings and features

- Maximum discharge current (8/20µs): 40kA
- Nominal discharge current (8/20µs): 20kA
- Ucpv: 65, 80, 660, 1060 Vdc and 1500Vdc
- Iscpv: 10kA (EN 50539-11), no back-up fuse required
- SCCR: 50-100kA (UL 1449 4th Ed)
- DIN-rail mountable, plug-in format
- Visual and remote end of life indicators
- Reversible chassis to allow cable entry from above or below
- Mechanically coded cartridges to avoid cartridge replacement errors

Imax

40kA

No back-up fuse required

Approvals/Standards

- EN 50539-11
- IEC 61643-31
- UL 1449 4th Ed recognized, File No. E468946
- CE

Catalogue numbers / Reference numbers

REFERENCE NUMBER	CATALOGUE NUMBER	Network								Cartridge Id.
		SYSTEM TYPE	ELECTRICAL DIAGRAM	UCPV [VDC]	ISCPV [A]	IMAX (8/20) [KA]	IN (8/20) [KA]	UP@IN (8/20) [KV]	REMOTE INDICATION (M)	
Y PV. LARGE-SCALE AND ROOFTOP PV										
83020138	STPT2-40K600V-YPV	"Y" PV	A	660	10 000	40	20	≤2.6		C40
83020139	STPT2-40K600V-YPVM	"Y" PV	A	660	10 000	40	20	≤2.6	✓	C40
83020140	STPT2-40K1000V-YPV	"Y" PV	A	1060	10 000	40	20	≤4		C41
83020141	STPT2-40K1000V-YPVM	"Y" PV	A	1060	10 000	40	20	≤4	✓	C41
83020158	STPT2-40K1500V-YPV	"Y" PV	A	1500	10 000	40	15	≤5		C42
83020159	STPT2-40K1500V-YPVM	"Y" PV	A	1500	10 000	40	15	≤5	✓	C42
U PV. SELF-CONSUMPTION										
83020128	STPT2-40K60V-2P	TNS (1Ph+N); PV	B	65	1000	40	20	≤0.7		Consult
83020129	STPT2-40K60V-2PM	TNS (1Ph+N); PV	B	65	1000	40	20	≤0.7	✓	Consult
83020130	STPT2-40K75V-2P	TNS (1Ph+N); PV	B	80	1000	40	20	≤0.8		Consult
83020131	STPT2-40K75V-2PM	TNS (1Ph+N); PV	B	80	1000	40	20	≤0.8	✓	Consult

Replacement cartridges

REF. NUMBER	CATALOGUE NUMBER	NETWORK	UCPV [VDC]	IMAX (8/20) [KA]	IN (8/20) @UP [KA]	UP@IN (8/20) [KV]	CARTRIDGE ID.
83020005	SP2-40K600V-PV	PV	330	40	20	≤1.3	C40
83020006	SP2-40K1000V-PV	PV	530	40	20	≤2	C41
83020010	SP2-40K1500V-PV	PV	750	40	10	≤2,5	C42

Microswitch diagram

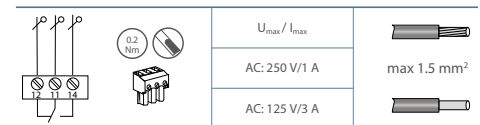

Dimensions

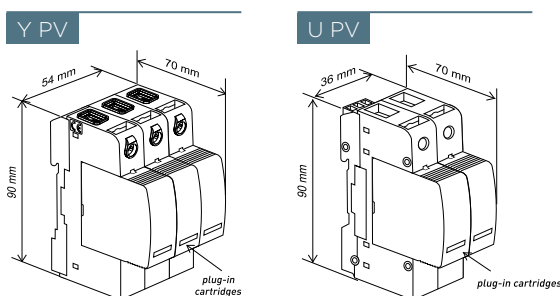

Electrical diagram

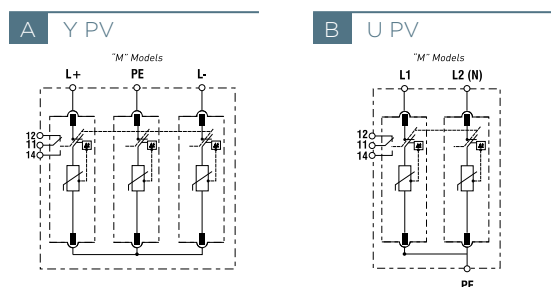

SURGE-TRAP® DC T2 & T1+2 MPPT PHOTOVOLTAIC SPD

STP MPPT PV

STP MPPT PV is the PHOTOVOLTAIC range of combined Type 1+2 / Class I+II and T2 / Class II devices intended for discharging lightning currents (10/350 μ s) and protecting against induced voltage surges (8/20 μ s), in accordance with EN 50539-11, IEC 61643-31 and UL 1449 (for Type 2).

Mersen uses a dynamic thermal disconnection system with high breaking capacity, optimised for DC voltages. This means there is no need to install a backup fuse to interrupt the typical short-circuit currents of any photovoltaic installation.

The devices are suitable for all PV applications: large-scale and rooftop. Includes specific multipole products for multiple maximum power point tracker (MPPT) inverters.

Ratings and features

- Maximum discharge current (8/20 μ s): 40kA
- Nominal discharge current (8/20 μ s): 20kA
- For Type 1+2, lightning impulse current (10/350 μ s): 5kA
- Ucpv: 1060 Vdc
- Iscpv: 10 kA (EN 50539-11), no back-up fuse required
- Multipole MPPT specific products
- DIN-rail mountable, plug-in format
- Visual and remote end of life indicators
- Reversible chassis to allow cable entry from above or below
- Mechanically coded cartridges to avoid replacement errors

limp

5kA

Imax

40kA

Approvals/Standards

- EN 50539-11
- IEC 61643-31
- UL 1449 4th Ed recognized, File No. E468946
- CE

Catalogue numbers / Reference numbers

REFERENCE NUMBER	CATALOGUE NUMBER	Network									Cartridge Id.
		SYSTEM TYPE	ELECTRICAL DIAGRAM	UCPV [VDC]	ISCPV [A]	IIMP (10/350) [KA]	IMAX (8/20) [KA]	IN (8/20) [KA]	UP@IN (8/20) [KV]	REMOTE INDICATION (M)	
TYPE 1+2											
83120192	STPT12-5K1000V-5YPVM	3+, 1-, 1PE	A	1060	10000	5	40	20	4	✓	C43
83120206	STPT12-5K1000V-5Y2PVM	2+, 2-, 1PE	C	1060	10000	5	40	20	4	✓	C43
83120190	STPT12-5K1000V-8YPVM	6+, 1-, 1PE	B	1060	10000	5	40	20	4	✓	C43
TYPE 2											
83020188	STPT2-40K1000V-5YPVM	3+, 1-, 1PE	A	1060	10000	-	40	20	4	✓	C41
83020223	STPT2-40K1000V-5Y2PVM	2+, 2-, 1PE	C	1060	10000	-	40	20	4	✓	C41
83020204	STPT2-40K1000V-8YPVM	6+, 1-, 1PE	B	1060	10000	-	40	20	4	✓	C41

Replacement cartridges

REF. NUMBER	CATALOGUE NUMBER	NETWORK	UCPV [VDC]	IIMP (10/350) [KA]	IMAX (8/20) [KA]	IN (8/20) [KA]	UP@IN (8/20) [KV]	CARTRIDGE ID.
83020006	SP2-40K1000V-PV	PV	530	-	40	20	≤2	C41
83020011	SP12-5K1000V-PV	PV	530	5	40	20	≤2	C43

Microswitch diagram

U _{max} / I _{max}	
AC: 250 V/1 A	max 1.5 mm ²
AC: 125 V/3 A	

Dimensions

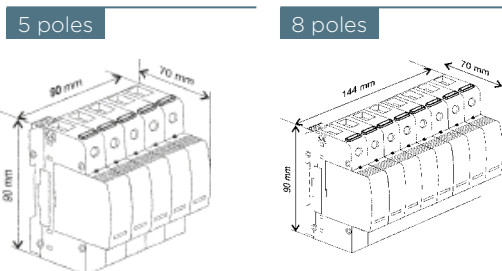

Electrical diagram

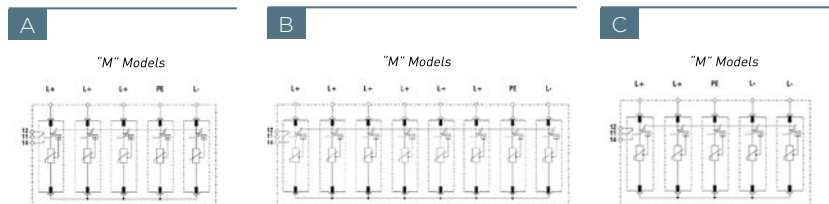

SURGE-TRAP® SPD PV BOXES FOR INVERTERS

PV BOX

PV BOX is the series of DC photovoltaic surge protection connection boxes for inverters to IEC/EN standard.

Such boxes are ready for installation and just need to be connected in parallel upstream of residential and light commercial string inverters of several MPPT trackers, mainly 1000Vdc rooftop installations.

Available in several configurations including Type 1+2 or Type 2 surge protection with MC4 or cable gland connectors. Please consult for availability and models, for instance 5pole and 8pole SPDs.

Ratings and features

- Pre-assembled junction box with SPDs for 1000VDC
- Quick installation of the DC protection, next to the inverter
- MC4 or cable gland connectors
- 1 or 2 MPPT versions
- 1 or 2 string inputs per MPPT
- Type 1+2 5kA Iimp or Type 2 40kA Imax SPDs
- Visual end of life indicator
- DC Switch disconnecter available

Iimp Imax

5kA **40kA**



Approvals/Standards

- IEC/EN 61439-12
- IEC/EN 61643-31
- CE



Catalogue numbers / Reference numbers

REFERENCE NUMBER	CATALOGUE NUMBER	NUMBER OF MPP TRACKERS	STRING INPUTS PER MPPT	IMAX PER STRING [KA]	PLUGGABLE CARTRIDGE	DIMENSIONS	ELECTRICAL DIAGRAM	CONNECTOR TYPE
TYPE 1+2								
83070102	PVBT12-1000V-BH-113	1	1	40	SP12-5K1000V-PV	I	A	MC4
83070106	PVBT12-1000V-BH-213	2	1	40	SP12-5K1000V-PV	II	B	MC4
83070110	PVBT12-1000V-BH-223	2	2	20	SP12-5K1000V-PV	III	D	MC4
83070010	PVBT12-1000V-BH-225	2	2	20	SP12-5K1000V-PV	III	D	CABLE GLAND
83070002	PVBT12-1000V-B-113	1	1	40	SP12-5K1000V-PV	I	A	CABLE GLAND
83070006	PVBT12-1000V-B-213	2	1	40	SP12-5K1000V-PV	II	B	CABLE GLAND
83070016	PVBT12-1000V-B-215	2	1	40	SP12-5K1000V-PV	II	C	CABLE GLAND
TYPE 2								
83070100	PVBT2-1000V-BH-113	1	1	40	SP2-40K1000V-PV	I	A	MC4
83070104	PVBT2-1000V-BH-213	2	1	40	SP2-40K1000V-PV	II	B	MC4
83070108	PVBT2-1000V-BH-225	2	2	20	SP2-40K1000V-PV	III	D	MC4
83070008	PVBT2-1000V-B-225	2	2	20	SP2-40K1000V-PV	III	D	CABLE GLAND
83070000	PVBT2-1000V-B-113	1	1	40	SP2-40K1000V-PV	I	A	CABLE GLAND
83070004	PVBT2-1000V-B-213	2	1	40	SP2-40K1000V-PV	II	B	CABLE GLAND
83070014	PVBT2-1000V-B-215	2	1	40	SP2-40K1000V-PV	II	C	CABLE GLAND

Other boxes available. Contact Mersen for more information.

Dimensions

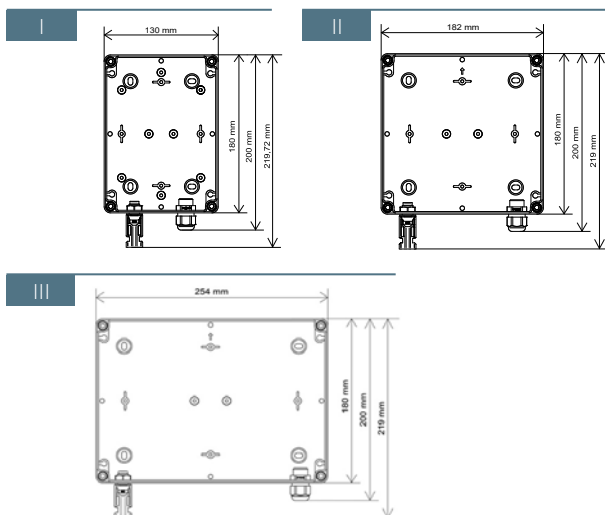

Electrical diagram

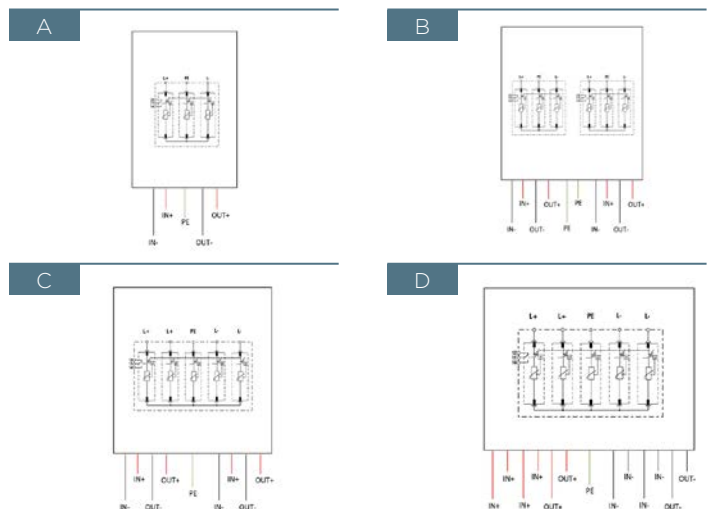

SURGE-TRAP® PCB PLUG-IN OR DIRECT ASSEMBLY

SB-PCB

SB PCB is the series of socket bases that allow for integration of Mersen's pluggable IEC surge protection cartridges directly on printed circuit boards. These surge cartridges will be easily replaceable upon reaching end of life.

SB PCB is an optimal solution for the industry of power electronics: inverters, converters, control panels for railway, PV combiner boxes, machines, OEM equipment, etc. Key benefits are cost efficiency, space efficiency, no wiring and optimal voltage protection of sensitive electronics.

Integration of surge protection on PCBs is often planned for at an early stage of development of the system. The surge sockets will be firmly fixed to the PCB during the wave soldering process. They'll host the entire range of IEC surge protection cartridges AC & DC, T2 & T1.

Ratings and features

- Single pole sockets. All system configurations on PCBs.
- Up to 1500 VDC
- T1 & T2 surge protection (IEC 61643-11)
- Remote end of life indicator
- Voltage ratings DC: 660 - 1500V_{DC}
- Voltage ratings AC: 60 - 850V_{AC}
- Mechanical coding to avoid cartridge insertion errors
- Vibration proof (EN 60721-3-3)
- Cost efficiency
- Space efficiency
- No wiring
- Optimal voltage protection

Catalogue numbers / Reference numbers

REFERENCE NUMBER	CATALOGUE NUMBER	UCPV [VDC]	REMOTE INDICATION (M)	Cartridge Id.	
				REFERENCE NUMBER	CATALOGUE NUMBER
DC SIDE					
83050133	SB-PCB-1000PV-M	1000	√	83020006	SP2-40K1000V-PV
83050135	SB-PCB-1500PV-M	1500	√	83020010	SP2-40K1500V-PV
AC SIDE					
83050119	SB-PCB-275V-M	275	√	83020002	SP2-40K275V
83050123	SB-PCB-440V-M	440	√	83020004	SP2-40K440V
83050127	SB-PCB-750V-M	750	√	83020007	SP2-30K750V
83050129	SB-PCB-N-M	neutral	√	83020000	SP2-40K-N

Dimensions

1 pole

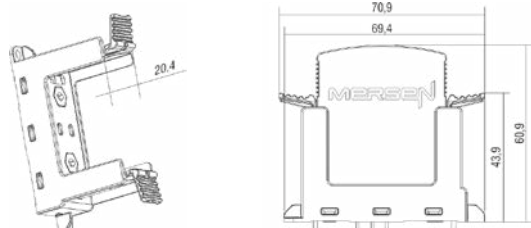

limp I_{max}

25kA **80kA**



Approvals/Standards

- IEC/EN 61643-11
- CE

SURGE-TRAP® PCB PLUG-IN OR DIRECT ASSEMBLY

SP-PCB

Compact SPD SP-PCB base can be soldered directly on to the PCB, cartridges are pluggable and replaceable. This solution can save cost and installation space effectively, with no wiring and provides sensitive electronic components with optimal surge protection. SPD sockets will be fixed on PCB firmly during soldering.

The compact SP-PCB is an optimal solution for industrial power electronics: inverters, converters, control panel for railway, PV combiner box and others.

Ratings and features

- Single pole design.
Apply to all system structure on PCBs; Apply to anti-failure Y-circuits circuit protection structure (PV or AC).
- Up to 1500 VDC
Air clearance & creepage distances comply with requirements of all applications (PV DC and AC).
- Fixed and reliable.
SPD module has anti-vibration function and is easy to replace.
- T2 surge protection.
Mechanical stress of Type 2 discharges won't loosen the protection module.
- Remote indication.
Protection pole is equipped with visual end of life indication.

Imax **25kA**



Approvals/Standards

- IEC/EN 61643-31
- UL 1449 4th Ed recognized, File No. E468946

Catalogue numbers / Reference numbers

REFERENCE NUMBER	CATALOGUE NUMBER	UCPV [VDC]	IMAX (8/20) [KA]	IN (8/20) @UP [KA]	UP@IN (8/20) [KV]	DIMENSIONS
84020012	SP2-10KA-PV	up to 670	Socket directly soldered into PCB			A
84020013	SP2-10K500V-PV	500	25	10	≤ 1,5	B
84020014	SP2-10K670V-PV	670	25	10	≤ 1,8	B
84020016	SP2-10K900V-PV	900	25	10	≤ 2,5	C

Dimensions

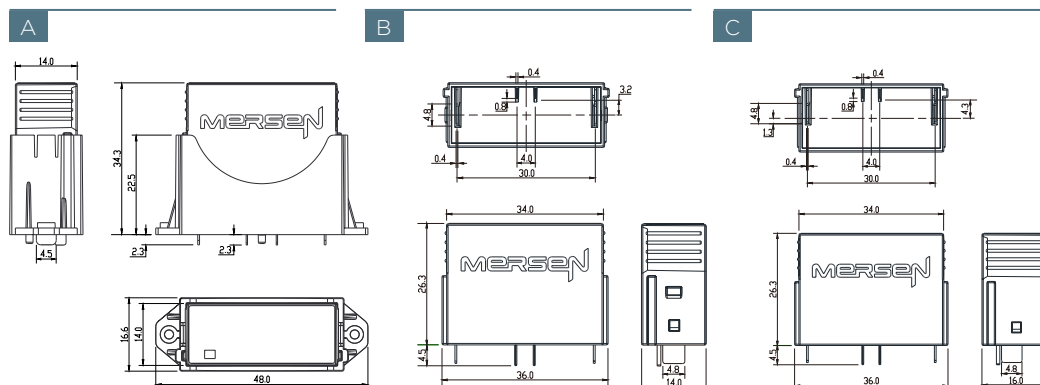

Electrical diagram

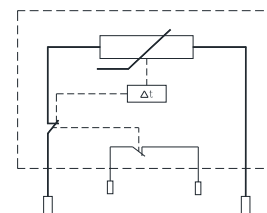

SURGE-TRAP® AC TYPE 1+2 PHOTOVOLTAIC SPD

STP T12 5

STP T12 5 is the series of combined Type 1+2 /Class I+II devices for discharging lightning currents and protecting against voltage surges, in accordance with IEC/EN 61643-11 and UL 1449.

Suitable as the first step of protection for the AC side in photovoltaic systems that supply power to the grid, especially installations which are provided with an external lightning protection system due to their exposure.

The series comprehends specific models for applications where high withstand voltage peaks are required, such as in the case of PV grid side with induced DC offsets or wind turbine generators.

Also suited for first or second stage of protection in commercial or residential applications.

Ratings and features

- Lightning impulse current (10/350µs): 5kA per phase
- Maximum discharge current (8/20µs): 40kA per phase
- Nominal discharge current (8/20µs): 20kA per phase
- TNS, TNC, TT and IT networks
- Un(L-N/L-L): 230/400V, 277/480V, 400/690V & higher
- DIN-rail mountable, plug-in format
- Visual and remote end of life indicators
- Reversible chassis to allow cable entry from above or below
- Mechanically coded cartridges to avoid cartridge replacement errors

Catalogue numbers / Reference numbers

REFERENCE NUMBER	CATALOGUE NUMBER	Network									Cartridge Id.	
		SYSTEM TYPE	ELECTRICAL DIAGRAM	UN [VAC]	UC [V]	IIMP (10/350) [KA]	IMAX (8/20) [KA]	IN (8/20) [KA]	UP@IN (8/20) [KV]	REMOTE INDICATION (M)	L	N
83120238	STPT12-5K320V-1P	L-N (1Ph)	A	277	320	5	40	20	≤1.5		C51	
83120239	STPT12-5K320V-1PM	L-N (1Ph)	A	277	320	5	40	20	≤1.5	√	C51	
83120240	STPT12-25K-N1	N-PE	B	Neutral	277	5	40	20	≤1.5			C53
83120214	STPT12-5K320V-2P	TNS (1Ph+N)	D	277	320	5	40	20	≤1.5		C51	
83120215	STPT12-5K320V-2PM	TNS (1Ph+N)	D	277	320	5	40	20	≤1.5	√	C51	
83120241	STPT12-5K320V-2PG	TT (1Ph+N)	C	277	320	5	40	20	≤1.5 / 1.5		C51	
83120242	STPT12-5K320V-2PGM	TT (1Ph+N)	C	277	320	5	40	20	≤1.5 / 1.5	√	C51	C53
83120202	STPT12-5K320V-3P	TNC (3Ph)	E	- / 480	320	5	40	20	≤1.5		C51	C53
83120203	STPT12-5K320V-3PM	TNC (3Ph)	E	- / 480	320	5	40	20	≤1.5	√	C51	
83120222	STPT12-5K320V-4P	TNS (3Ph+N)	H	277 / 480	320	5	40	20	≤1.5		C51	
83120223	STPT12-5K320V-4PM	TNS (3Ph+N)	H	277 / 480	320	5	40	20	≤1.5	√	C51	
83120200	STPT12-5K320V-4PG	TT (3Ph+N)	G	277 / 480	320	5	40	20	≤1.5 / 1.5		C51	C53
83120201	STPT12-5K320V-4PGM	TT (3Ph+N)	G	277 / 480	320	5	40	20	≤1.5 / 1.5	√	C51	C53
IT (3PH) - REINFORCED PEAK WITHSTAND												
83120243	STPT12-5K680V-3P-R	IT (3Ph)	F	800	1360	5	40	20	≤5		C52	
83120244	STPT12-5K680V-3P-RM	IT (3Ph)	F	800	1360	5	40	20	≤5	√	C52	
83120261	STPT12-5K320V-3P-R	IT (3Ph)	F	400	640	5	40	20	≤3		C51	
83120262	STPT12-5K320V-3P-RM	IT (3Ph)	F	400	640	5	40	20	≤3	√	C51	

Replacement cartridges

REF. NUMBER	CATALOGUE NUMBER	NETWORK	UN [VAC]	UC [V]	IMAX (8/20) [KA]	IN (8/20) @ UP [KA]	UP@IN (8/20) [KV]	CARTRIDGE ID.
83120020	SP12-5K320V	L-N (1Ph)	277	320	40	20	≤ 1,5	C51
83120015	SP12-25K-N1	N-PE (N)	Neutral	277	40	20	≤ 1,5	C53
83120025	SP12-5K680V	L-N (1Ph)	680	680	40	20	≤ 2,5	C52



SURGE-TRAP® AC TYPE 1+2 PHOTOVOLTAIC SPD

Dimensions

1 pole

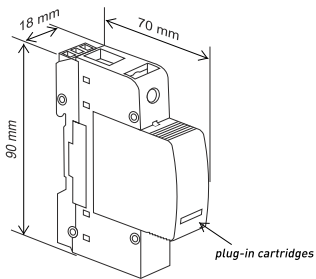

2 poles

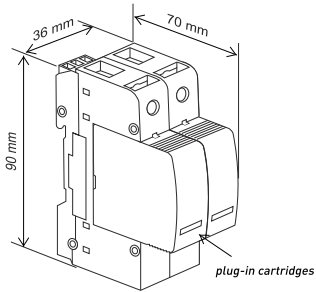

3 poles

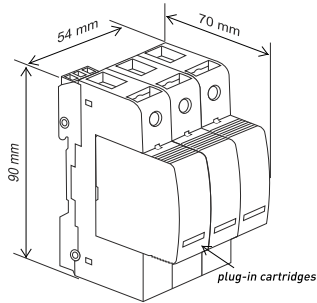

4 poles

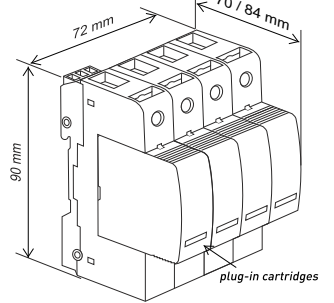

Electrical diagrams

A (1P)

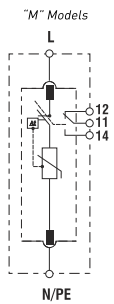

B (N)

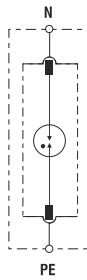

C 1+1 (2PG)

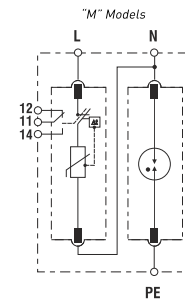

D 2+0 (2P)

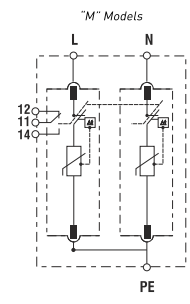

E 3+0 (3P)

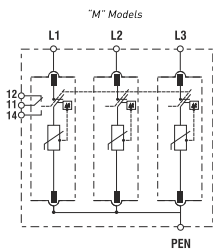

F 3+1 (3P reinforced)

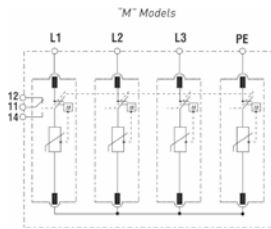

G 3+1 (4PG)

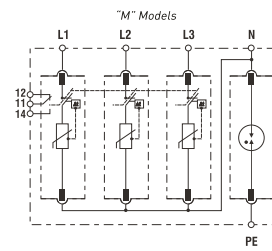

H 4+0 (4P)

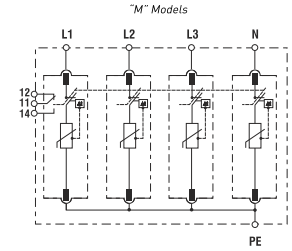

Microswitch diagram

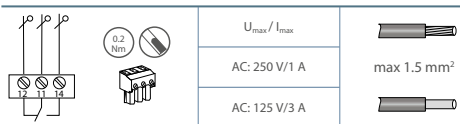

SURGE-TRAP® AC TYPE 2 PHOTOVOLTAIC SPD

STP T2 40

STP T2 40 3P is the series of type 2 /class II devices for discharging voltages surges, in accordance with IEC/EN 61643-11 and UL 1449. Suitable for the AC side protection in photovoltaic systems that provide power to the grid. Also suitable for first or second stage of protection in commercial and residential applications.

Ratings and features

- Maximum discharge current (8/20µs): 40kA per phase
- Nominal discharge current (8/20µs): 20kA per phase
- TNS, TNC, TT and IT networks
- Un(L-N/L-L): 48V, 60V, 120/208V, 230/400V, 277/480V, 400/690V & higher
- DIN-rail mountable, plug-in format
- Visual and remote end of life indicators
- Reversible chassis to allow cable entry from above or below
- Mechanically coded cartridges to avoid cartridge replacement errors

Imax

40kA



Approvals/Standards

- IEC/EN 61643-11
- UL 1449 4th Ed recognized, File No. E468946
- CE



Catalogue numbers / Reference numbers

REFERENCE NUMBER	CATALOGUE NUMBER	Network								Cartridge Id.
		SYSTEM TYPE	ELECTRICAL DIAGRAM	UN [VAC]	UC [V]	IMAX (8/20) [KA]	IN (8/20) [KA]	UP@IN (8/20) [KV]	REMOTE INDICATION (M)	L
83020134	STPT2-40K275V-3P	TNC (3Ph)	D	-/400	275	40	20	≤1.3		C23
83020135	STPT2-40K275V-3PM	TNC (3Ph)	D	-/400	275	40	20	≤1.3	√	C23
83020136	STPT2-40K320V-3P	TNC (3Ph)	D	-/480	320	40	20	≤1.4		C24
83020137	STPT2-40K320V-3PM	TNC (3Ph)	D	-/480	320	40	20	≤1.4	√	C24
83020102	STPT2-30K750V-3P	TNC (3Ph)	D	-/690; -/1000	750	30	15	≤3		C26
83020103	STPT2-30K750V-3PM	TNC (3Ph)	D	-/690; -/1000	750	30	15	≤3	√	C26
83020246	STPT2-30K850V-3P	TNC (3Ph)	D	-/690; -/1000	850	30	15	≤3		C28
83020247	STPT2-30K850V-3PM	TNC (3Ph)	D	-/690; -/1000	850	30	15	≤3	√	C28
83020100	STPT2-30K750V-1P	L-N (1Ph)	C	690	750	30	15	≤3		C26
83020101	STPT2-30K750V-1PM	L-N (1Ph)	C	690	750	30	15	≤3	√	C26
83020234	STPT2-30K850V-1P	L-N (1Ph)	C	690	850	30	15	≤3		C28
83020235	STPT2-30K850V-1PM	L-N (1Ph)	C	690	850	30	15	≤3	√	C28

Replacement cartridges

REF. NUMBER	CATALOGUE NUMBER	NETWORK	UN [VAC]	UC [V]	IMAX (8/20) [KA]	IN (8/20) [KA]	UP@IN (8/20) [KV]	CARTRIDGE ID.
83020002	SP2-40K275V	L-N (1Ph)	230	275	40	20	≤1.3	C23
83020003	SP2-40K320V	L-N (1Ph)	277	320	40	20	≤1.4	C24
83020007	SP2-30K750V	L-N (1Ph)	690	750	30	15	≤3	C26
83020022	SP2-30K850V	L-N (1Ph)	690	850	30	15	≤3	C28

Microswitch diagram

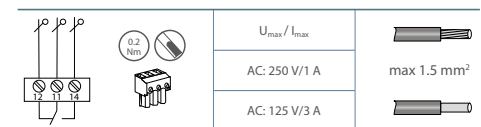

Dimensions

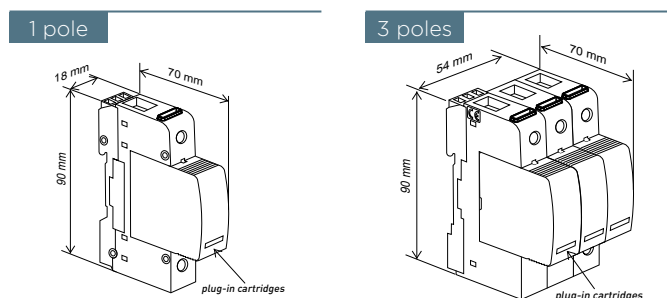

Electrical diagram

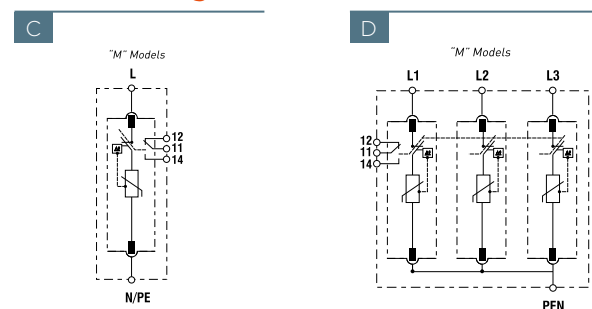

SURGE-TRAP® AC TYPE 2 REINFORCED PEAK WITHSTAND PHOTOVOLTAIC SPD

STP T2 30 3P-R

STP T2 30 3P-R is the series of type 2 /class II devices for discharging voltage surges, in accordance with IEC/EN 61643-11 and UL 1449. Suitable for AC side protection in photovoltaic systems that provide power to the grid. Suitable for special applications where high withstand voltage peaks are required. PV grid side with induced DC offsets or wind turbine generators.

Ratings and features

- Maximum discharge current (8/20µs): 30kA per phase
- Nominal discharge current (8/20µs): 15kA or 20kA per phase
- TNC and IT networks
- Un(L-N/L-L): 400/690V & higher
- Voltage peak withstand up to 2,2kV
- DIN-rail mountable, plug-in format
- Visual and remote end of life indicators
- Reversible chassis to allow cable entry from above or below
- Mechanically coded cartridges to avoid cartridge replacement errors

Imax

30kA



Approvals/Standards

- IEC 61643-11
- UL 1449 4th Ed recognized, File No. E468946
- CE



Catalogue numbers / Reference numbers

REFERENCE NUMBER	CATALOGUE NUMBER	Network									Cartridge Id.	
		SYSTEM TYPE	ELECTRICAL DIAGRAM	UN [VAC]	UC [V]	IMAX (8/20) [KA]	IN (8/20) [KA]	UP@IN (8/20) [KV]	REMOTE INDICATION (M)	UPEAK (L-PE) [KV]	L	PE
83020177	STPT2-30K440V-3P-R	IT	A	- / 400	440	30	20	5		1,6	C25	C26
83020178	STPT2-30K440V-3P-RM	IT	A	- / 400	440	30	20	5	√	1,6	C25	C26
83020213	STPT2-30K750V-3P-R	IT	A	- / 690	750	30	15	6		2,1	C26	C26
83020214	STPT2-30K750V-3P-RM	IT	A	- / 690	750	30	15	6	√	2,1	C26	C26
83020201	STPT2-30K850V-3P-R	IT	A	- / 690	850	30	15	6		2,2	C28	C28
83020202	STPT2-30K850V-3P-RM	IT	A	- / 690	850	30	15	6	√	2,2	C28	C28

Replacement cartridges

REF. NUMBER	CATALOGUE NUMBER	NETWORK	UN [VAC]	UC [V]	IMAX (8/20) [KA]	IN (8/20) [KA]	UP@IN (8/20) [KV]	CARTRIDGE ID.
83020004	SP2-40K440V	L-N [1Ph]	400	440	40	20	≤2	C25
83020007	SP2-30K750V	L-N [1Ph]	690	750	30	15	3	C26
83020022	SP2-30K850V	L-N [1Ph]	690	850	30	15	3	C28

Microswitch diagram

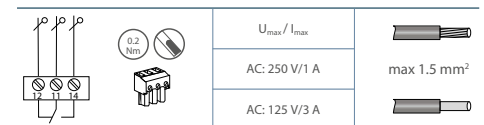

Dimensions

4 poles

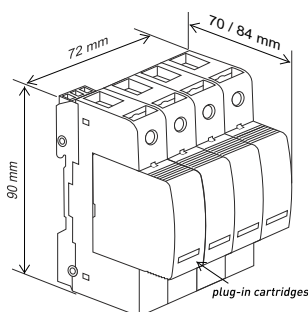

Electrical diagram

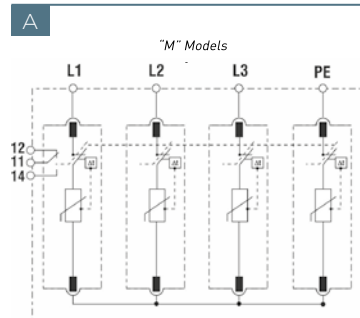

LIGHTNING AND SURGE PROTECTION



OUTDOOR LED LIGHTING



- OUTDOOR LED LIGHTING | NEED FOR PROTECTION 50
- SURGE-TRAP[®] HIGHLIGHTS 51
- SURGE-TRAP[®] TYPE 2+3 SPDS 52
- POP+SPD | COMBINED PROTECTION AT THE LIGHTING PANEL 55

Comprehensive protection

Surge protection devices (SPD) protect equipment by discharging the overvoltage to earth, thus limiting the voltage reaching the equipment (residual voltage).

An effective overvoltage protection design comprises of staggered protection, with stages for each of the sensitive components in the installation. With this method, part of the overvoltage is discharged in each protection stage until only a small residual voltage is left close to the luminaire.

Protection in the lighting panel 1 although necessary, is by itself insufficient because overvoltages can also be induced in long cable runs, which means that the **final protection should always be as close as possible to the equipment being protected 2 3**.

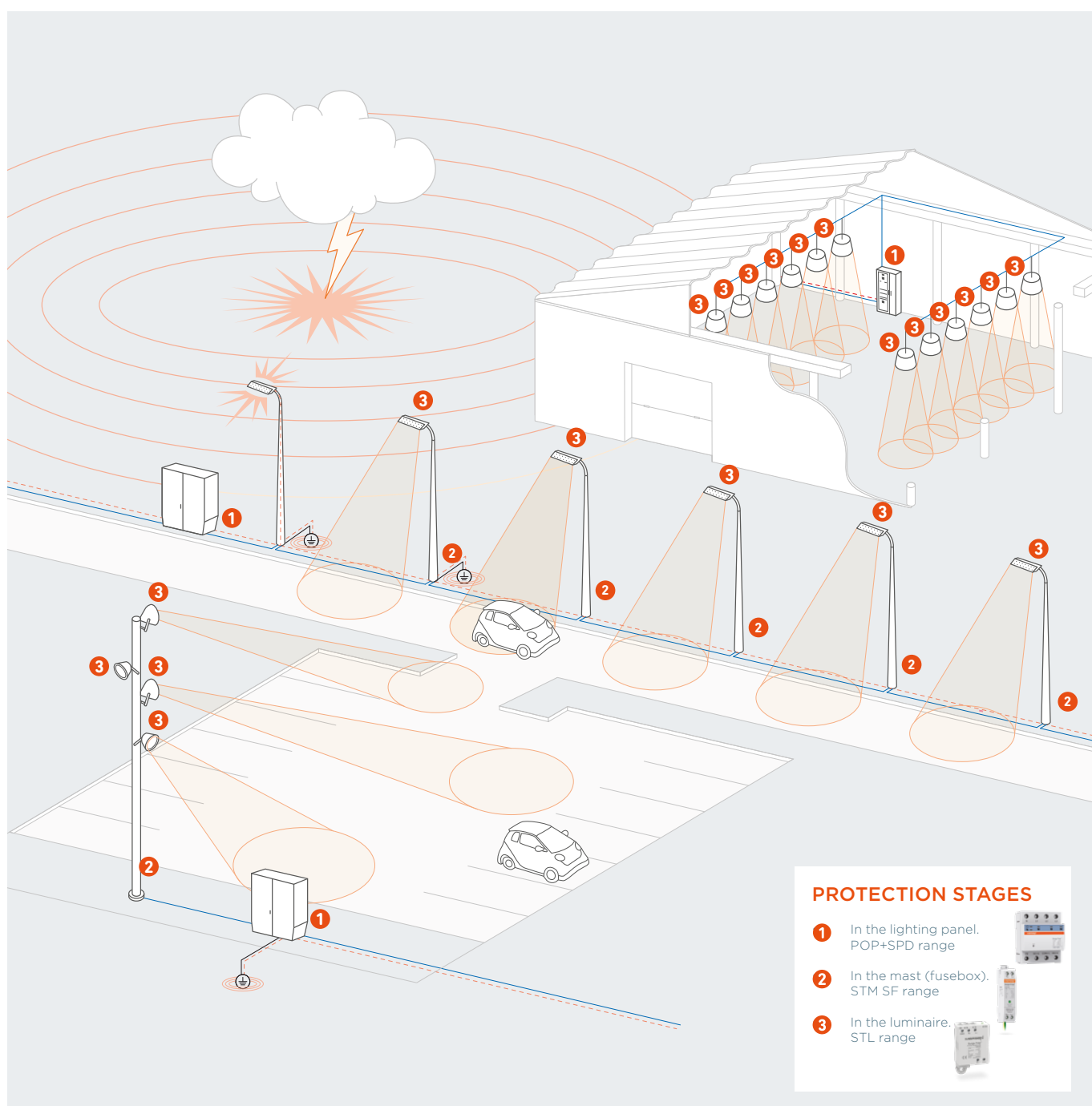

SURGE-TRAP® HIGHLIGHTS

STL T23 | LUMINAIRE

See pages 52 and 53

Certified

- KEMA KEUR certification to IEC 61643-11 
- First SPD for lighting fixtures to have ENEC certification  

Proven quality

- STL series protects LED outdoor luminaires since 2011
- More than 8.000.000 effectively protected luminaires

Double end-of-life indication

- Disconnection, if installed in series, the SPD will turn the luminaire off when it reaches end-of-life.
- Visual LED indication.

No leakage current

- STL with common mode protection has no leakage current to earth. 

Versatile assembly

- The SPD can be installed upright or flat depending on the space constraints of the luminaire

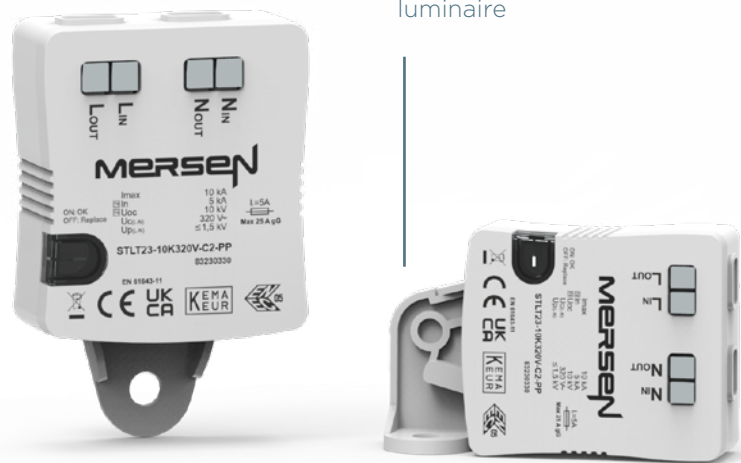

STM T23 | MAST

See page 54

- Design adapted for the **fuse box**
- Perfect for **retrofitting**
- Compact and robust (**10kV / 10kA**)
- Ground cable/Ground terminal options 



POP + SPD | LIGHTING PANEL

See page 55

- Combined power frequency overvoltage protection and surge protection device
- First step of protection
- Remote and visual **indication of life status** of the protection device



SURGE-TRAP® TYPE 2+3 SPDs

STL T23 10

STL T23 10 is the series of robust 10kV combined Type 2+3/Class II+III devices for discharging voltage surges while providing a very fine voltage protection level, in accordance with IEC/EN 61643-11. It is suitable for protection of LED outdoor luminaires (street-light). Due to the exposure of the extremely sensitive LED electronics to lightning-induced overvoltages, STL T23 10 is a widespread market solution amongst OEM manufacturers of LED lighting systems.

Ratings and features

- Combined voltage pulse (1.2/50µs): 10kV (Uoc)
- Maximum discharge current (8/20µs): 10kA
- Nominal discharge current (8/20µs): 5kA
- Class 1 and Class 2 luminaires
- Miniature size and easy to install
- End of life indication
- Push in terminals (in and out)

Uoc

10kV



Approvals/Standards

- IEC/EN 61643-11
- KEMA & ENEC certifications
- CE





Catalogue numbers / Reference numbers

REFERENCE NUMBER	CATALOGUE NUMBER	Network		Un [Vac]	Uc [V]	Imax (8/20) [kA]	In (8/20) [kA]	Uoc [kV]	Up@In (8/20) [kV]	IL [A]
		SYSTEM TYPE	ELECTRICAL DIAGRAM							
83230330	STLT23-10/320-C2-PP	C2	A	230	320	10	5	10	≤1.5 (L1-L2)	5
83230333	STLT23-10/320-C4-PP	C4	B	230	320	10	5	10	≤1.5 (L1-L2) ≤1.8 (L1/L2-GND)	5

Dimensions

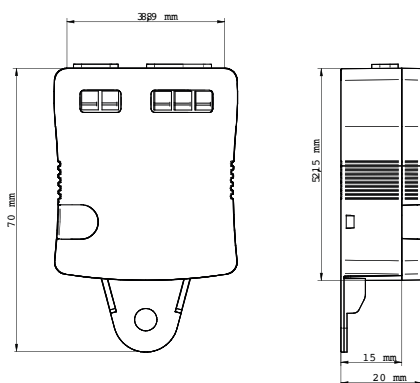

Electrical diagrams

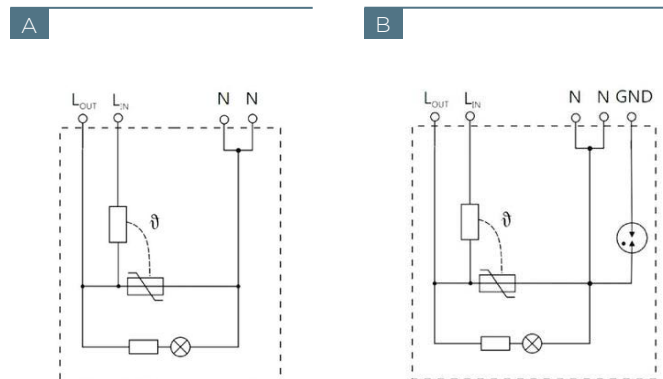

Accessory for vertical assembly

An accessory is available that allows the SPD to be installed upright or flat, depending on the space constraints of the luminaire.

Consult with your Mersen sales contact.

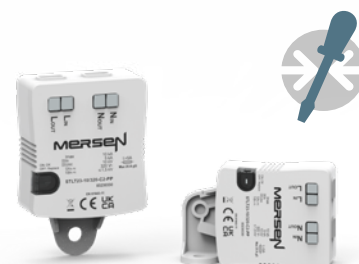

SURGE-TRAP® TYPE 2+3 SPDs

STLB T23 20

STL T23 20 is the series of robust 20kV combined Type 2+3/Class II+III devices for discharging voltage surges while providing a very fine voltage protection level, in accordance with IEC/EN 61643-11.

Ratings and features

- Combined voltage pulse (1.2/50µs): 20kV (Uoc)
- Maximum discharge current (8/20µs): 20kA
- Nominal discharge current (8/20µs): 10kA
- End of life indication
- Screw terminals (in and out)



Uoc 
20kV

Approvals/Standards

- IEC/EN 61643-11
- CE



STLB T23 10 IP

STL T23 10 IP is the series of robust 10kV combined Type 2+3/Class II+III devices for discharging voltage surges with IP66, in accordance with IEC/EN 61643-11.

Ratings and features

- Combined voltage pulse (1.2/50µs): 10kV (Uoc)
- Maximum discharge current (8/20µs): 10kA
- Nominal discharge current (8/20µs): 5kA
- End of life indication
- IP 66



Uoc 
10kV

150 mm
1,5 mm²

Approvals/Standards

- IEC/EN 61643-11
- CE



Catalogue numbers / Reference numbers

REFERENCE NUMBER	CATALOGUE NUMBER	Network		Un [Vac]	Uc [V]	Imax (8/20) [kA]	In (8/20) @Up [kA]	Uoc [kV]	Up [kV]	IL [A]
		SYSTEM TYPE	ELECTRICAL DIAGRAM							
STLB T23 20										
83230321	STLBT23-20K275V-C4-DD	C4	C	230	275	20	10	20	≤ 1.5 (L-N) ≤ 1.8 (N-GND)	2,5
STLB T23 10 IP										
83230311	STLBT23-20K275V-C4-WW-IP	C4	C	230	320	10	5	10	≤ 1.5 (L-N) ≤ 1.8 (N-GND)	2,5

Dimensions

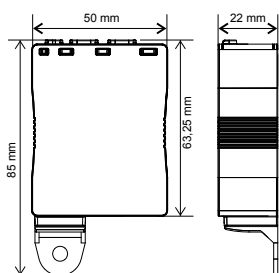

Electrical diagrams

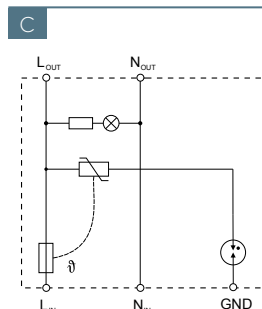

SURGE-TRAP® TYPE 2+3 SPDs

STM T23 10 SF / SE

STM T23 10 SF is the series of robust 10kV combined Type 2+3/ Class II+III devices for discharging voltage surges while providing a very fine voltage protection level, in accordance with IEC/EN 61643-11. **STM T23 10** has been designed to be installed in the mast/fusebox.

STM T23 10 SF has ground cable while **STM T23 10 SE** has ground terminals. Their dimensions are different to suit various different sizes of fusebox.

Ratings and features

- Combined voltage pulse (1.2/50µs): 10kV (Uoc)
- Maximum discharge current (8/20µs): 10kA
- Nominal discharge current (8/20µs): 5kA
- End of life indication
- For DIN-rail fuseboxes



Catalogue numbers / Reference numbers

REFERENCE NUMBER	CATALOGUE NUMBER	SYSTEM TYPE	ELECTRICAL DIAGRAM	Un [Vac]	Uc [V]	Imax (8/20) [kA]	In (8/20) @Up [kA]	Uoc [kV]	Up [kV]	IL [A]
83230512	STMT23-10K320V-SP-SF	C4	A	230	320	10	5	10	≤ 1.5 (L-N) ≤ 1.8 (N-PE)	2,5
83230515	STMT23-10K320V-SP-SE	C4	B	230	320	10	5	10	≤ 1.5 (L-N) ≤ 1.8 (N-PE)	10

Dimensions

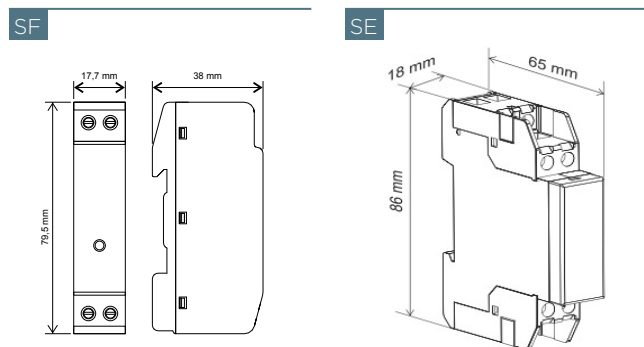

Electrical diagrams

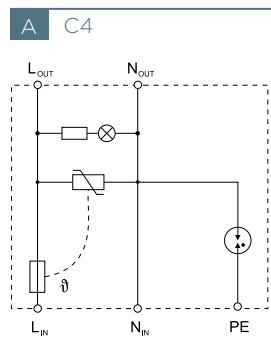

POP+SPD | COMBINED PROTECTION AT THE LIGHTING PANEL

POP+SPD

Combined **POP + SPD** protector. 2 in 1.

POP+SPD is the series of combined transient and power frequency overvoltage protection devices, which includes solutions that especially meet outdoor lightning protection requirements.

These devices are intended for installation within the lightning panel as a 1st step of surge protection while providing protection against temporary overvoltages to all the luminaires installed downstream of the panel.

Ratings and features

- Maximum discharge current (8/20 μ s): 40 kA
- Nominal discharge current (8/20 μ s): 15 kA
- U_n (L-N/L-L): 230/400 V
- End of life indication (LED)
- DIN rail mountable, monobloc format
- POP device to EN 50550, with Test Button
- POP actuation and reconnection via contactor (not included)
- Auto reconnect after voltage stabilisation via contactor



Approvals/Standards

- EN 50550
- EN/IEC 61643-11
- CE



Catalogue numbers / Reference numbers

REFERENCE NUMBER	CATALOGUE NUMBER	ELECTRICAL DIAGRAM	U_n [Vac]	POP	SPD Type 2			ACTUATION METHOD	REMOTE (M)
				U_a [V]	I_{max} (8/20) [kA]	I_n (8/20) [kA]	$U_p@I_n$ (8/20) [kV]		
83060100	POP-40K230V-CT-4P	A	230/400	> 275	40	15	$\leq 1,8$	Contactor	
83060101	POP-40K230V-CT-4PM	B	230/400	> 275	40	15	$\leq 1,8$	Contactor	✓

Dimensions

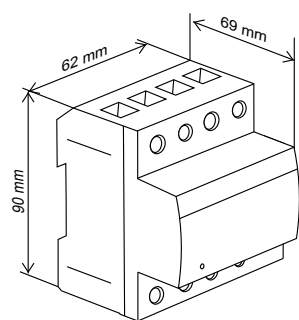

Electrical diagrams

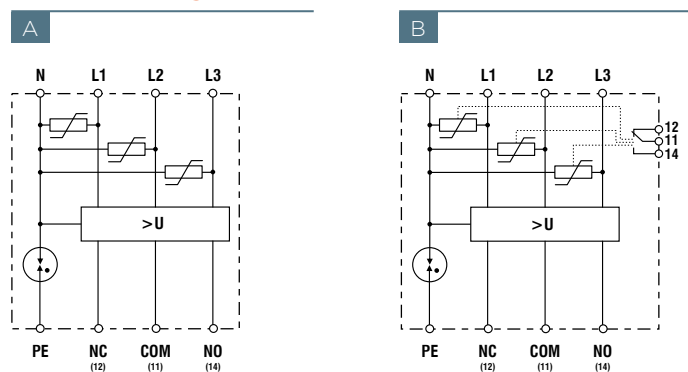

Microswitch diagram

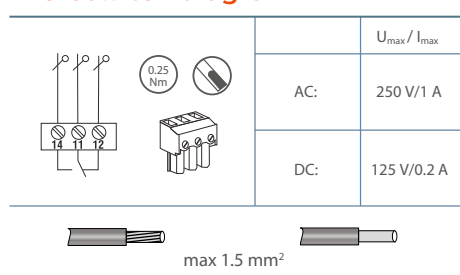



LIGHTNING AND SURGE PROTECTION

GROUNDING SYSTEM MONITORING



- SURGE-TRAP® TERRA..... 58
- GROUND MONITORING INSIDE THE SPD 59
- CONFIGURABLE GROUNDING SYSTEM MONITORING 60
- GMD® 61

SURGE-TRAP® TERRA

Monitoring the grounding system in the surge protection device itself

For the protection to work properly, the correct status of the grounding system in an electrical installation is essential.

DID YOU KNOW that nobody knows what percentage of installed surge protection devices are providing good protection?

TERRA® is the first protection device on the market that, in addition to indicating that it is properly wired, guarantees that there is an adequate path to ground, which is essential if the protection device is to shunt the energy peaks to ground effectively.

The premium solution for the most demanding installations

TERRA®'s simple information makes it the ideal solution for both unskilled personnel and maintenance professionals specialised in ground connections.

It helps to avoid situations that might cause power cuts and repair costs, with the resulting damage to your brand image.

It provides additional information about the grounding system, with potential synergies for protection and safety in general, not just for surge protection.

TERRA®

Technology

TERRA® is based on the impedance loop technology already patented, sold and implemented by Mersen in thousands of protection solutions. TERRA® patent pending.

Ground status indicator

Continuous LED display of ground status.

NO CONNECTION



POOR



CORRECT



The best SPD on the market

TERRA® is the premium protection device in the Mersen STP range, designed according to the most exacting standards. Intelligent protection.

Wiring safety

The only protection device on the market that tells you when it is properly installed, avoiding risks due to electrical wiring errors.



GROUND MONITORING INSIDE THE SPD

Confirmation of proper installation

Almost 25 years of experience in the sector confirm that it is relatively common for wiring **errors to occur** during the installation of surge protection devices. These errors result in the **loss of protection or risks to the installation itself**.



When the TERRA® LED is green, it means that the protection device is properly wired and powered up. Green for Go.

Effective surge protection

Even when equipped with surge protection devices, the electrical installation may still be subject to the effects of overvoltage if the ground connection is inadequate or in poor condition.



When the TERRA® LED is green, it indicates that the ground path is good enough to shunt the energy peaks to ground effectively. Green for Go.

Safety information in the event of indirect contact

Just as happens with surge protection devices, the safety of the electrical installation in the event of indirect contact is based on there being a grounding connection.



When TERRA® cannot detect any ground connection, it is advisable to check the installation status.

Ratings and features

- Patented TERRA® technology for loop impedance monitoring
- Confirmation of correct device wiring at installation time
- Continuous indication of the effectiveness of the protection offered
- Additional safety information in the event of indirect contact
- Maximum discharge current (8/20 μs): 40 kA per phase
- Nominal discharge current (8/20 μs): 20 kA per phase
- TT and TNS networks
- Un (L-N/L-L): 230/400 V
- Plug-in DIN rail format

Catalogue numbers / Reference numbers

REFERENCE NUMBER	Catalogue NUMBER	Network		Un [V]	Uc [V]	Imax (8/20) [kA]	In (8/20) [kA]	Up@In (8/20) [kV]
		SYSTEM TYPE	ELECTRICAL DIAGRAM					
83020183	STPT2-40K275V-2P-TE	1Ph+N	A	230	275	40	20	≤1,3w
83020185	STPT2-40K275V-4P-TE	3Ph+N	B	230/400	275	40	20	≤1,3 (L-N) ≤1,5 (N-PE)

Dimensions

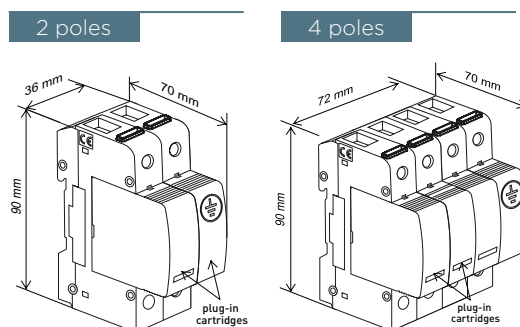

Electrical diagrams

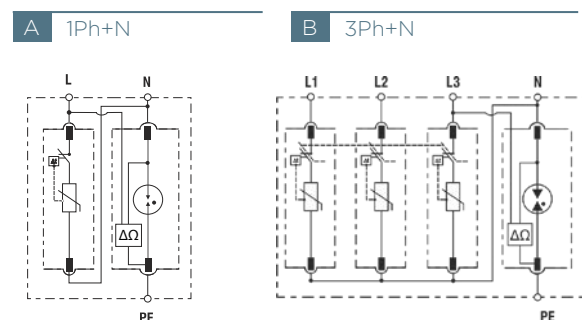

CONFIGURABLE GROUNDING SYSTEM MONITORING

GMD®

GMD® is a control device that continuously monitors the state of the ground connection:

- Ensures proper operation of surge protection devices (SPDs) that discharge energy through the facility ground connection.
- Provides additional safety information to avoid indirect contact.
- Reduces preventative maintenance costs.

By the loop resistance calculation method, GMD® checks the impedance of the actual leakage path of an indirect contact, enabling it to **detect the following possible incidents**, both in the installation itself and in transformer centre to which it is connected:

- **Deterioration of the ground connection** due to ageing of the earth rods, due to theft or increased soil resistivity during dry periods.
- **Breakage or incorrect wiring of the neutral cable.**

Ratings and features

- The system of grounding measurement by loop impedance can be applied to the various neutral configurations: TT, TNS and TNC-S
- Un (L-N/L-L): 120/208 V, 230/400 V
- Monobloc DIN rail format
- Alarm function on the ground value (PE). Activates the output if it detects a value shown on the display exceeding a maximum preset by the user

24/7

Grounding system monitoring

Easy to install

Panel mounting

Assists with maintenance

Complementary to regular grounding system maintenance

Real-time monitoring of the grounding system condition

Monitors

Cable theft / Soil resistivity

Cable breakage / poor connection

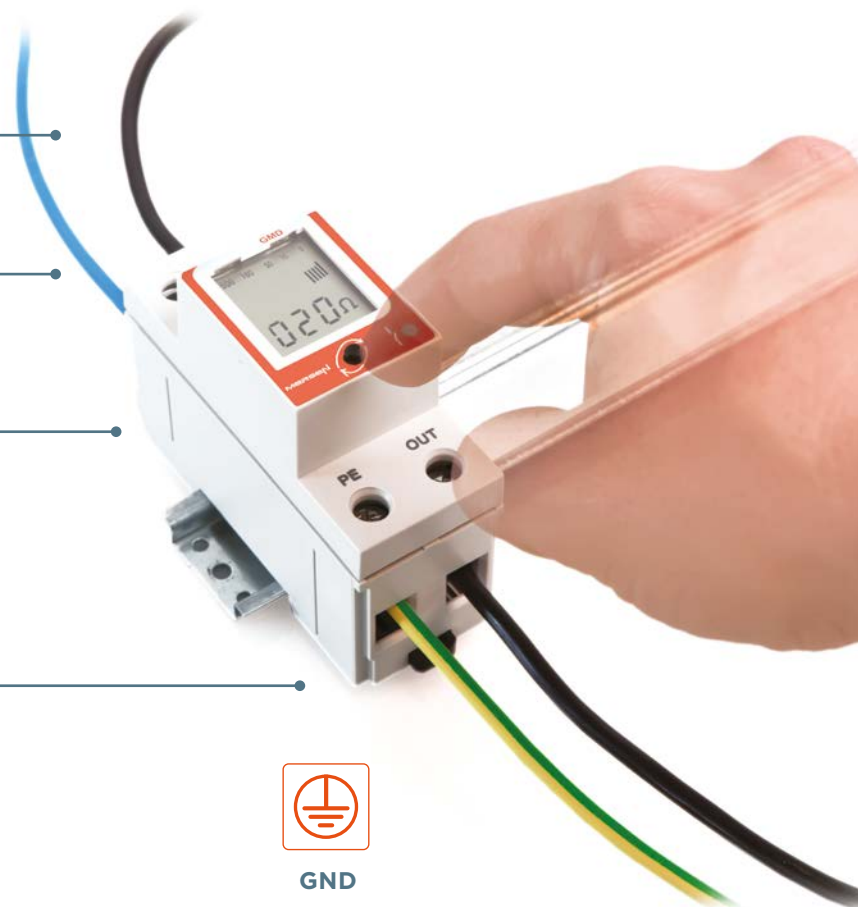

GND

Importance of grounding systems

- Having proper grounding and checking it regularly is very important.
- A ground in proper condition avoids risk of death for people and destruction of property.
- A ground in proper condition ensures protection against voltage surges.



Catalogue numbers / Reference numbers

REFERENCE NUMBER	CATALOGUE NUMBER	Un [V]	FREQUENCY [Hz]	SETTING THRESHOLD	OUTPUT RELAY	RESPONSE TIME
83060251	GMD-120V	120	50 / 60	1...500 Ω	1 (OUT-N)	inst.
83060250	GMD-230V	230	50 / 60	1...500 Ω	1 (OUT-N)	inst.

Dimensions

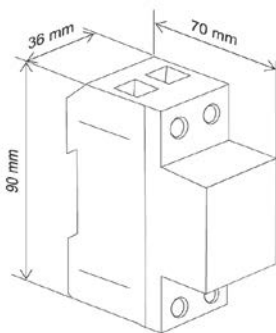

Measurement

Measurement loop or leakage current loop in TT systems.

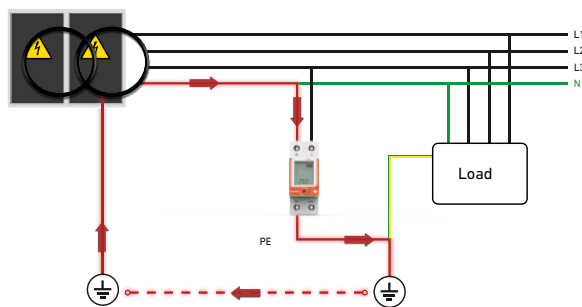

A photograph of a server room with rows of server racks. The racks are illuminated from above, and there are some blue and green lights visible on the racks. The text "LIGHTNING AND SURGE PROTECTION" is overlaid in white, bold, uppercase letters.

LIGHTNING AND SURGE PROTECTION

TELECOM & SIGNALLING NETWORKS



- SURGE-TRAP[®] SIGNAL DATA NETWORKS & MEASUREMENT AND CONTROL.....64
- SURGE-TRAP[®] SIGNAL MEASUREMENT AND CONTROL65
- SURGE-TRAP[®] SIGNAL RADIOFREQUENCY.....66
- SURGE-TRAP[®] SIGNAL TELEPHONE LINES67
- SURGE-TRAP[®] SIGNAL MEASUREMENT AND CONTROL65

SURGE-TRAP® SIGNAL DATA NETWORKS & MEASUREMENT AND CONTROL

STS NET (Ethernet)

Depending on the structure of the network in which they are used, they are classified by Ethernet categories into Cat. 5E, Cat. 6 and Cat. 6 with Power over Ethernet (using two pairs for communications and two for power supply).

These are protectors for a final step of very fine protection to be installed as close as possible to particularly sensitive equipment connected to these communication lines. Meets the IEC 61643-21 standard.



Catalogue numbers / Reference numbers

REFERENCE NUMBER	CATALOGUE NUMBER	Un [V]	Uc [V]	In (8/20) [kA]	Up at In [V]	IL [A]	BANDWIDTH (fg) [MHz]	PROTECTED WIRES	CONNECTION TYPE
CAT 5									
83040510	STS-NET-CAT5-1P	5	6	0.25	≤ 35	0.1	100	4 Pairs	RJ45
CAT 6									
83040520	STS-NET-CAT6-1P	5	6	0.25	≤ 35	0.1	250	4 Pairs	RJ45
83040525	STS-NET-CAT6-PoE-1P	5 48	6 55	0.25	≤ 35 ≤ 130	0.1 1	250	4 Pairs	RJ45

STS PLC

Cover a wide variety of applications in communications signals, such as RS232, RS485, 4-20 mA, Binary, KNX, PTC or Modbus. These ranges offer a number of formats, voltages and numbers of lines protected and are designed especially for such applications.

These are protectors for a final step of very fine protection to be installed as close as possible to particularly sensitive equipment connected to these communications lines. Meets the IEC 61643-21 standard.



Catalogue numbers / Reference numbers

REFERENCE NUMBER	CATALOGUE NUMBER	Un [V]	Uc [V]	Imax (8/20) [kA]	In (8/20) [kA]	Up at In [V]	IL [A]	BANDWIDTH (fg) [MHz]	PROTECTED WIRES	CONNECTION TYPE
2 wires										
83040220	STS-PLC-30V-2W	24	30	5	5	≤ 45	0.3	3	2 Wires	Spring terminal
83040221	STS-PLC-30V-2W-C1	24	30	5	5	≤ 50	0.37	3	2 Wires	Spring terminal
83040222	STS-PLC-30V-2W-C2	24	30	5	5	≤ 60	0.35	3	2 Wires	Spring terminal
83040223	STS-PLC-30V-2W-C3	24	30	5	5	≤ 40	0.3	3	2 Wires	Spring terminal
4 wires										
83040211	STS-PLC-30V-4W1	24	30	5	5	≤ 120	0.5	2	4 Wires	Spring terminal

SURGE-TRAP® SIGNAL MEASUREMENT AND CONTROL

STS 485

STS 485 is the new series of type D1 and C2 surge protection devices for signal lines in accordance with IEC/EN 61643-21. Especially designed for protecting RS485/RS232 communication lines used in PV applications against induced overvoltages. Suitable as a dedicated protection for special equipment connected to communication lines (i.e. string monitor), providing an extremely fine voltage protection level and an optimal discharge capacity.

Ratings and features

- Maximum discharge current (8/20): 10kA (I_{max})
- Type D1 maximum discharge current (10/350 μ s): 2,5kA (I_{limp})
- Type C2 nominal discharge current (8/20 μ s): 5kA (I_n)
- Models with end of life indication
- Multiple voltage options for different requirements (6, 12, 24V)
- Operational bandwidth (fg) up to 10MHz
- Extremely fine voltage protection level
- DIN rail mountable, monobloc format

Catalogue numbers / Reference numbers

REFERENCE NUMBER	CATALOGUE NUMBER	U_n [V]	U_c [V]	I_{max} (8/20) [kA]	I_n (8/20) [kA]	U_p at I_n [V] (L/L)	I_L [A]	BANDWIDTH (fg) [MHz]	PROTECTED WIRES	CONNECTION TYPE
2 wires										
83040111	STS485-7V-2W	6	7	10	5	≤ 10	0.1	1	1 Pair	DIN rail
83040112	STS485-16V-2W	12	16	10	5	≤ 20	0.1	1.2	1 Pair	DIN rail
83040113	STS485-27V-2W	24	27	10	5	≤ 40	0.1	4	1 Pair	DIN rail
83040114	STS485-56V-2W	48	56	10	5	≤ 70	0.1	5	1 Pair	DIN rail
2 wires + GND										
83040110	STS485-5K15V-3WI	12	15	10	5	≤ 45 (L/L) ≤ 400 (L-PE)	0.25	10	1 Pair + GND	DIN rail
4 wires + GND										
83040120	STS485-5V-4WG	5	5.2	10	10	≤ 30	0.45	60	2 Pairs + GND	DIN rail

I_{max}

10kA



STS485-7V-2W



STS485-5V-4WG



STS485-5K15V-3WI

Approvals/Standards

- IEC/EN 61643-21
- CE



SURGE-TRAP® SIGNAL RADIOFREQUENCY

STS RF

There are several different compatible products, depending on the type of cable and connector. These are protectors for a final step of very fine protection to be installed as close as possible to particularly sensitive equipment connected to these communication lines. Meets the IEC 61643-21 standard.

I_{max}

20kA



IEC CE

Approvals/Standards

- IEC/EN 61643-21
- CE

Catalogue numbers / Reference numbers

REFERENCE NUMBER	CATALOGUE NUMBER	U _n [V]	U _c [V]	I _{max} (8/20) [kA]	I _n (8/20) [kA]	U _p at I _n [V]	BANDWIDTH (fg) [MHz]	IMPEDANCE [Ω](OHM)	MAX. POWER [W]	
N (m-f)										
83040715	STS-RF-N	24	230	20	10	≤ 600	3000	75	100	
F (m-f)										
83040725	STS-RF-F	24	230	20	10	≤ 600	2500	75	100	
UHF (m-f)										
83040735	STS-RF-UHF	24	230	20	10	≤ 600	3000	50	150	

SURGE-TRAP® SIGNAL TELEPHONE LINES

STS TEL

These are classified by format, depending on the application, into free-standing (inline) on RJ12 cable, DIN rail, and Krone power strips. There are protectors for ADSL protocol in turn within these categories. These are protectors for a final step of very fine protection to be installed as close as possible to particularly sensitive equipment connected to these communication lines. Meets the IEC 61643-21 standard.

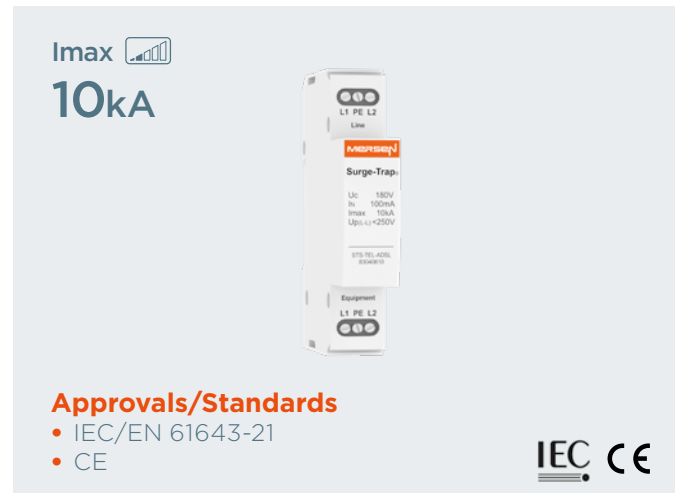

Catalogue numbers / Reference numbers

REFERENCE NUMBER	CATALOGUE NUMBER	Un [V]	Uc [V]	Imax (8/20) [kA]	In (8/20) [kA]	Up at In [V]	IL [A]	BANDWIDTH (fg) [MHz]	PROTECTED WIRES	CONNECTION TYPE
83040610	STS-TEL-ADSL	50	180	10	5	≤ 200	0.1	3	1 Pair	Terminal



SPD GENERAL INSTALLATION FEATURES

INSTALLATION & WIRING AND FUSES & FUSEHOLDERS



- INSTALLATION AND WIRING70
- FUSES & FUSEHOLDERS71

INSTALLATION AND WIRING

Recommended lengths and connection types according to 61643-12

In order to achieve optimum overvoltage protection, connecting conductors of SPDs shall be as short as possible. Long lead lengths will degrade the protection offered by the SPD.

When connecting an SPD in parallel, the optimal connection is a "V-type" (see image below). Whenever this is not feasible, the maximum derivation cable length should be less than 0.5m.

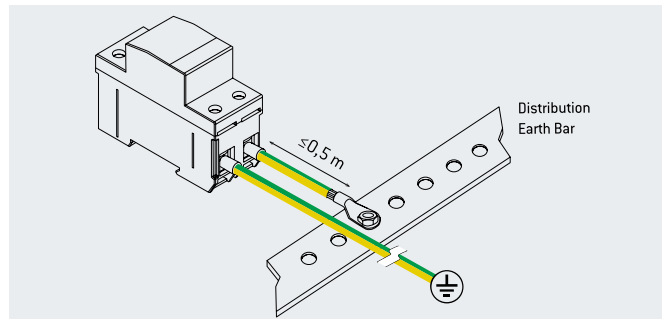

Wiring, general considerations (lengths and sections)

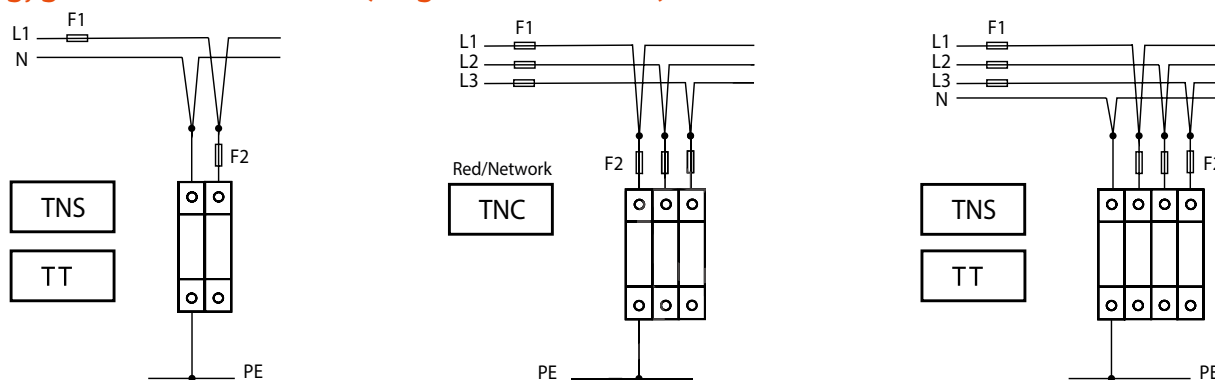

TYPE OF WIRE	STRANDED	RIGID
Ø min. L,N	6 mm ²	
Ø min. PE	6 mm ² {T2}/16mm ² {T1}	
Ø max. L,N,PE	25 mm ²	35 mm ²

Remote Indication

U _{max} / I _{max}		
	AC:	50V/1A
	DC:	125V/0,2A

When do we have to install a back-up fuse or circuit breaker?*

RANGE		MAXIMUM BACK-UP RATING ACCORDING TO MANUFACTURER		BACK-UP FUSE RECOMMENDED IN IEC61643
STP T12 25	limp 25 kA	If F1 > 315 A then ↓ F2 ≤ 315 A	If F1 ≤ 315 A then ↓ F2 not required	250 A gG
STP T12 12.5	limp 12.5 kA	F1 > 200 A ↓ F2 ≤ 200 A	If F1 ≤ 200 A then ↓ F2 not required	160 A gG
STP T2 40	I _{max} 40 kA	F1 > 125 A ↓ F2 ≤ 125 A	If F1 ≤ 125 A then ↓ F2 not required	63 A gG
STP T2 20	I _{max} 20 kA	F1 > 80 A ↓ F2 ≤ 80 A	If F1 ≤ 80 A then ↓ F2 not required	32 A gG

* If the main circuit breaker has a rating less than the maximum required by the SPD, then additional protection is not required.

FUSES & FUSEHOLDERS

SPD back-up fuse/ fuse holder guide selection

SPD			FUSE					
SPD RANGE	TYPE	RATING KA	MIN BACK-UP FUSE RECOMMENDED IN IEC61643	TYPE	3P&N FUSE HOLDER REFERENCE	3P FUSE HOLDER REFERENCE	FUSE REFERENCE GG	NEUTRAL LINK
STP T12 25	1+2	limp 25kA	250A gG	Multibloc DIN NH 1	Y1023061	S229878	E219815	A219834
STP T12 12	1+2	limp 12.5kA	160A gG	Multibloc DIN NH 00	J1023002	P1023007	P211084	Z218269
STP T2 40	2	Imax 40kA	63A gG	Modulostar 22x58	A331108	E331135	Y215646	N/A
STP T23 20	2+3	Imax 20kA	32A gG	Modulostar 22x58	A331108	E331135	F212594	N/A

MULTIBLOC® bottom fitting



CATALOG NUMBER	ITEM NUMBER	RATED VOLTAGE AC (IEC)	SIZE	POLES	CABLE TERMINATION COMPONENTS	DESIGN	PACKAGE	WEIGHT
1.000.405	Y1023061	690 VAC	NH1 250 A	4	8 M10 terminal screws	-	1 piece	3.4 kg
1.000.141	J1023002	690 VAC	NH00 160 A	4	8 M8 terminal screws	pole 4 right side	1 piece	1.04 kg
1.000.299	S229878	690 VAC	NH1 250 A	3	6 M10 terminal screws	-	1 piece	2.42 kg
2.030.000	P1023007	690 VAC	NH00 160 A	3	6 M8 terminal screws	-	1 piece	0.75 kg

NH fuse-links gG 500VAC



CATALOG NUMBER	ITEM NUMBER	RATED VOLTAGE AC (IEC)	RATED CURRENT IN	POWER DISSIPATION AT IN	PACKAGE	WEIGHT
NH1GG50V250	E219815	500 V	250 A	20 W	3	0.3 kg
NH00GG50V160	P211084	500 V	160 A	11.3 W	3	0.2 kg

Solid links with live tags



CATALOG NUMBER	ITEM NUMBER	SIZE	RATED CURRENT IN	PACKAGE	WEIGHT
NH1NEUTRAL	A219834	1	250 A	9	0.15 kg
NH00NEUTRAL	Z218269	000/00	160 A	15	80 g

Modulostar® CMS22 fuse-holders, without indicator



CATALOG NUMBER	ITEM NUMBER	NUMBER OF POLES/ PHASES	DESIGN	PACKAGE	WEIGHT
CMS223N	A331108	3 + N	CMS22 triple pole + neutral conductor	1	0.93 kg
CMS223	E331135	3	CMS22 triple pole	2	0.66 kg

Ferrule fuse-links 22x58 gG 500 to 690VAC



CATALOG NUMBER	ITEM NUMBER	RATED VOLTAGE AC (IEC)	RATED CURRENT IN	RATED BREAKING CAPACITY AC	POWER DISSIPATION AT IN	WEIGHT
FR22GG69V63	Y215646	690 V	63 A	120 kA	6.3 W	54 g
FR22GG69V32	F212594	690V	32 A	120 kA	3.7 W	54 g

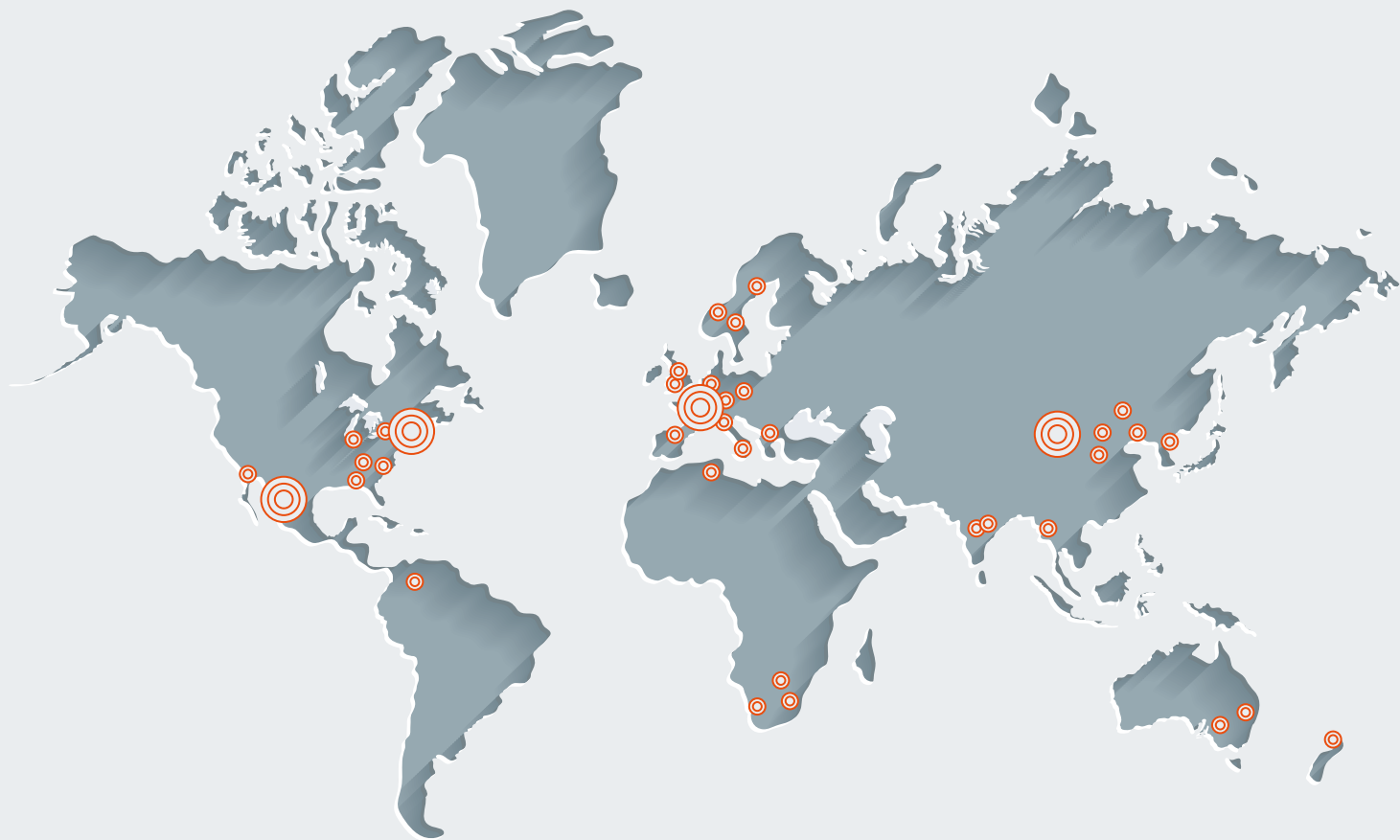

GLOBAL EXPERT
IN ELECTRICAL POWER
AND ADVANCED MATERIALS

EUROPE

FRANCE

Mersen France SB S.A.S.
15 rue Jacques de Vaucanson
F-69720 Saint-Bonnet-de-Mure
+33 4 72 22 66 11



EP.MERSEN.COM