

Protection against external faults in VSI

Jean-Louis Gelet

Mersen France SB SAS, Saint-Bonnet de Mure, France, jean.louis.gelet@mersen.com

Keywords: Protection, short-circuit, electric

This paper is a follow-up to a previous one entitled “Characterization of fuses for applications under high di/dt”. Topologies for electrical equipment are generally organized around a DC bus, fed by one or several sources and supplying power to inverters. If a semi-conductor in an inverter goes faulty, a short-circuit occurs in this inverter fed by the capacitor located ahead of the inverter. But, as the inductances between all the parallel inverters, through the DC bus, are very small, all the capacitors of these inverters will start to feed the short-circuit with only a small delay. Then the fuse in charge of internal protection within the faulty inverter will also have to bear actions from parallel capacitors. In other words, the fuse melts under the discharge of “its” capacitor. The current starts to decrease due to the arc-voltage generated by the fuse and suddenly, but very shortly, the “other capacitors” tend to increase the voltage of the source. There is actually a risk of re-ignition of the fuse in operation, depending on many parameters.

Fuse-designers are confronted with a complex topic including electrical and physical aspects. This paper will present the different considerations that MERSEN has engaged in order to gain insight and finally propose the right fuse for the right question.

Power Test-Station

MERSEN Electrical Protection has decided to increase the facilities of the test lab at Saint-Bonnet de Mure, in France. Main equipment concerns a new bench consisting of 4 stacks of capacitors. Each one of these stacks can be coupled under 2 and 4 kV. The capacitance of a stack reaches 32 mF under 2 kV and 8 mF under 4 kV. Capacitor stacks can be arranged in parallel, giving up to 126 mF under 2 kV.

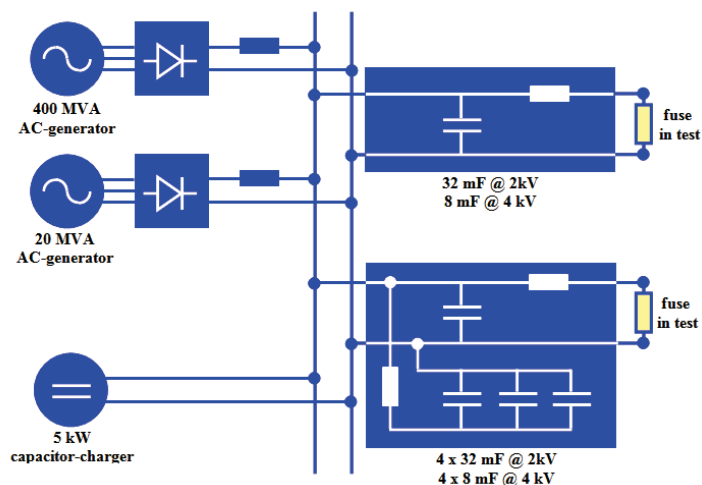

Figure 1: Synopsis of the test facilities at MERSEN - Saint-Bonnet de Mure, in France.

Thanks to the flexibility of the equipment, different kinds of tests can be run:

- Internal short-circuit
Only the inverter in which a short-circuit occurs is concerned.
Under 4 kV, di/dt will reach up to 5 kA/μs.

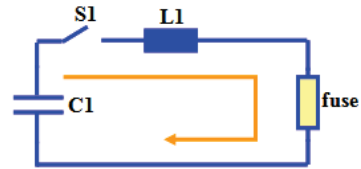

Figure 2 : Internal short-circuit

- Total short-circuit
Due to the short distances, hence low resistances and inductances between all the inverters plugged to the DC-bus, the capacitors of non-faulty inverters will discharge in the faulty inverter.

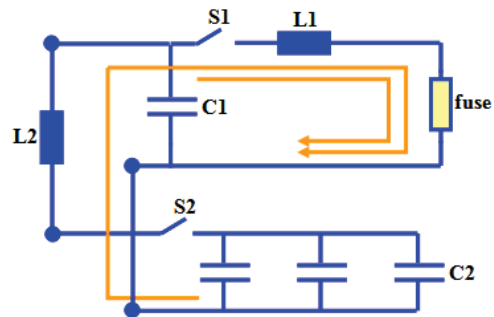

Figure 3 : Total short-circuit

The delay for re-applying voltage can be managed either by the value of the inductance L2 or by controlling time of closing of switches S1 and S2. In this case, it must be possible to close switches S1 and S2 at controlled times. Typically, as represented in fig. 4 hereafter, the delay between S1-closing and S2-closing will be about 100 μs. But this delay will be adjustable, from 0 to 10 ms by steps of 5 μs.

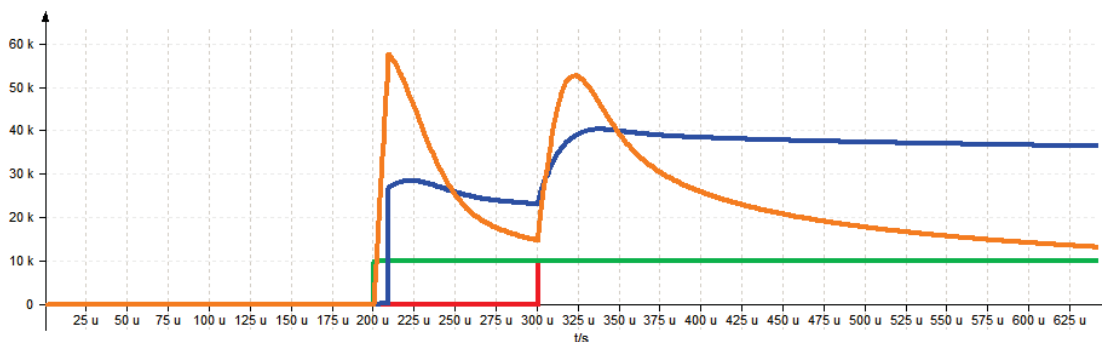

Figure 4 : ■ State of S1 ■ State of S2 ■ Current in the fuse ■ Voltage across the fuse

After the tests, switches S1 and S2 have to be opened at specified times. These times will be adjustable from 0 to 10 ms after closing S1.

- Upstream fed short-circuit
After discharge of the capacitor(s), the upstream generator feeds the short-circuit in the inverter. Due to the long distances, hence high inductances, it acts a long time later, but with a high amount of available energy.

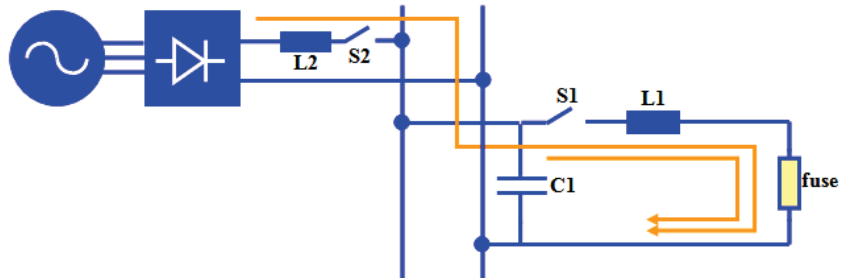

Figure 5 : Upstream fed short-circuit

Upstream fed short-circuits are assumed to be less critical as the inductance L2 is so high that voltage at the terminals of the fuse actually increases when operation is finished and secured. Also closing-time of the switch S2 will not be a test-parameter. S2 will be closed before S1.

Study of the transition between pre-arcing and arcing

For a long time, MERSEN has engaged in a partnership with the LAEPT (Laboratoire Arcs Electriques et Plasmas Thermiques) at Clermont-Ferrand (France). This lab has long experience and in-depth knowledge about electrical arcs, especially in fuses¹. The work is mainly related with spectroscopy and all information that could be extracted from observations, with a very specific interest for the few microseconds during which the arc is started.

Indeed, in the case of the I2-current of IEC 269, we get a pre-arcing time of about 3 to 4 ms and arcing-time of about 5 to 7 ms, with a transition (measured by the duration of the first voltage increase) of – very roughly – 50 µsec, i.e. less than 1% of the total operation time. In case of short-circuit under capacitor-discharge with very low inductance, very high di/dt occurs, of the order of several kA/µsec. Pre-arcing times are commonly observed between 10 and 100 µsec, i.e. of the same order as the transition between pre-arcing and arcing under I2-conditions.

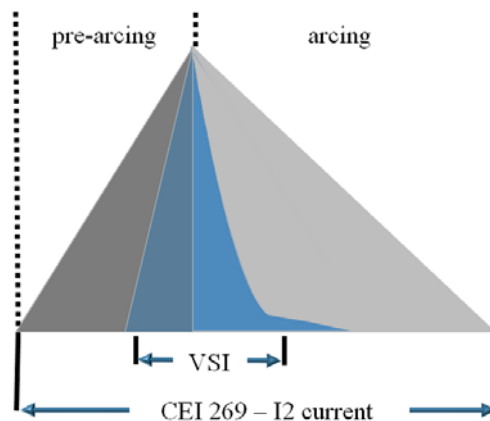

Figure 6 : Comparing pre-arcing and arcing currents for I2 in the IEC standard (in grey) and for high di/dt (in blue). Under high di/dt, the transition becomes crucial and requires in-depth study.

¹ The LAEPT organized the 8th ICEFA in Clermont-Ferrand in 2007.

It appeared to be interesting to draw nearer to the domain of exploded wires, which presents a rather large bibliography. Especially studies by Nasilowski [1], Graneau [2], Aspden [3] and Ternan [4], even though they are now relatively old, may be trustworthy foundations for our investigations. Out of them, Graneau reconsiders Ampère's equations in order to calculate the elementary force existing between two elementary current lines $i_m d_m$ and $i_n d_n$

$$dF = -i_m i_n \frac{d_m d_n}{d^2} (2 \cos(\epsilon) - 3 \cos(\alpha) \cos(\beta))$$

where ϵ , α and β are the angles between d_m and d_n .

For their part, MERSEN and LAEPT launched an experimental study on the principle of analysis of the radiation sprayed out of the plasma. Expected outputs concern mainly temperature and species-densities as these quantities may lead to the transport-coefficients, which are a characterization of the arc-plasma [5].

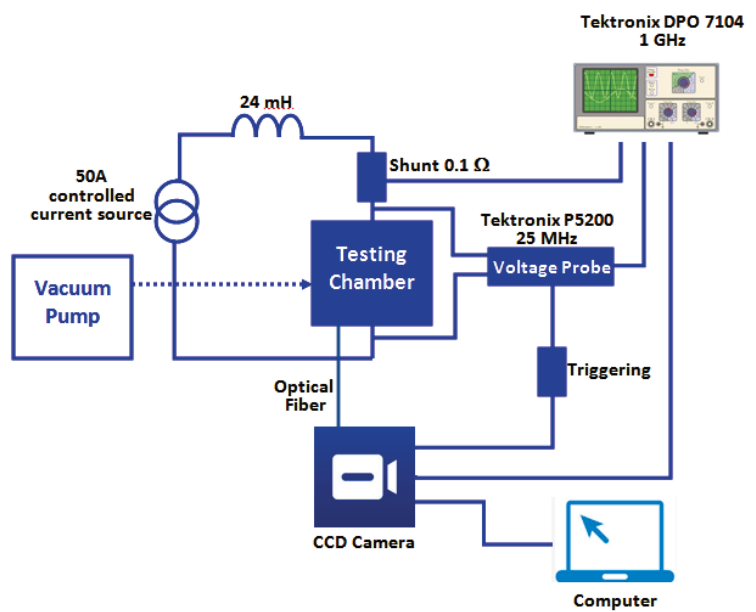

Figure 7 : General synopsis of the test equipment

Tests have been run on cylindrical wires and flat strips with reduced necks. Spectrometric observations detected some emissions of metallic vapors before the voltage increases. The temperature of these vapors can be estimated from the rays of the copper at 510, 515 and 521nm.

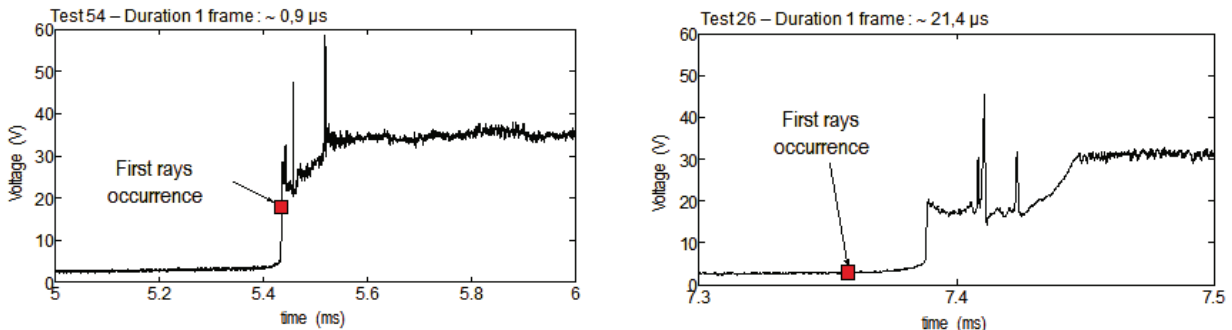

Figure 8 : Curves of the arc voltage and first copper rays occurrence. Longer recording durations improve the detection threshold of the vapors.

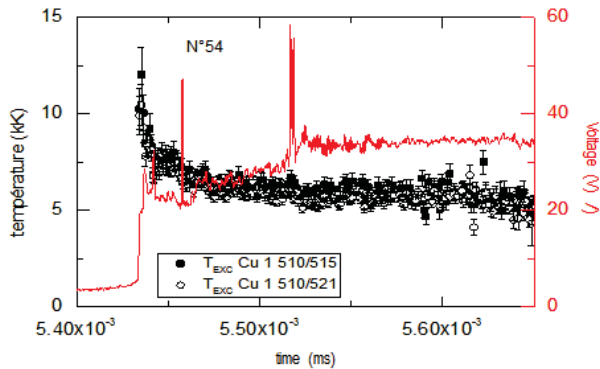

Figure 9 : Estimation of the temperature from spectrometric measurements and correlation with the voltage-curve

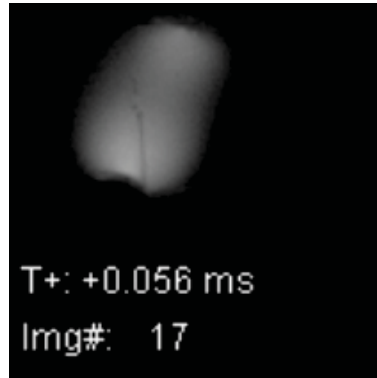

Figure 10 : Ultra-fast camera picture. The wire is still visible, while it is surrounded by metallic vapors or arc-plasma.

Thermodynamics of the electrical arc vs. granular medium

In case of VSI, or high di/dt operation, we have seen the great interest for the transition from pre-arcing to arcing. Another important point concerns the end of the arc. Under IEC 269 – I2 current, the voltage crosses over 0 every 10 ms. Then the fuse takes advantage of that to definitively open the circuit. Under VSI conditions, this chance never comes. We understand that the arc will stop according to many considerations: at first electrical ones (values of the capacitances, inductances, voltages, etc.), but also considerations of material (temperature, amount of vitrified materials, composition of the mixture, etc.)

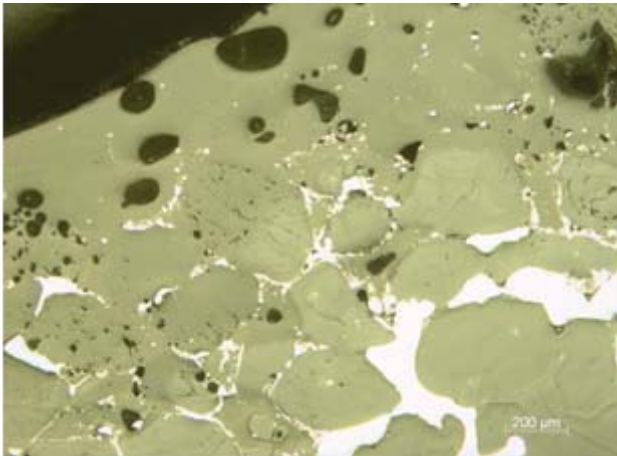

Figure 11: Melted silica grains and re-condensed silver.

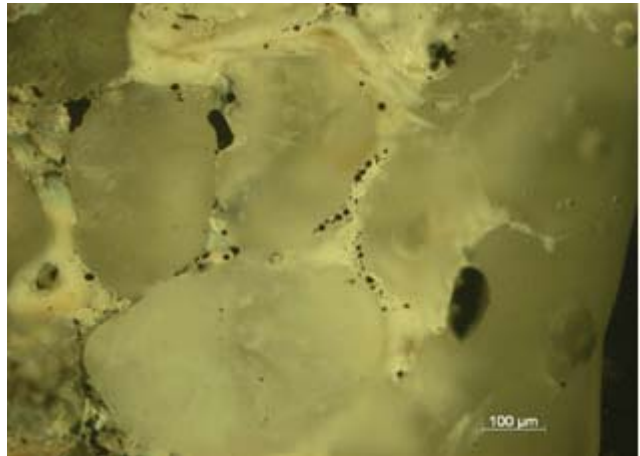

Figure 12: Curls of melted silica pushed by vapor-pressure through not-melted grains.

MERSEN has engaged in a partnership with the SIMAP lab (Science et Ingénierie des Matériaux et Procédés) at Grenoble (France) and the group SPIN of the ENSMSE (Ecole Nationale Supérieure des Mines) at Saint-Etienne (France). The principle of the study is to take advantage of experience with laser-engineering, both for testing and modeling [6] [7] [8].

From the point of view of testing, the laser presents the advantage of controlling the power, the duration and the size of the area where the energy is deposited. In a first step, the fact that there is no metal in the experiment and also no electrical charges is not a handicap.

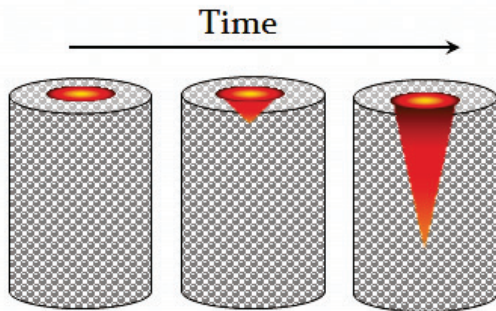

Figure 13: Over time, the laser beam penetrates inside the granular medium.

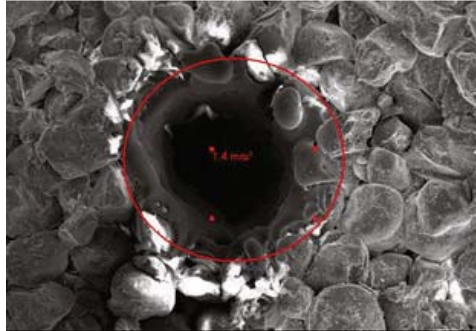

Figure 14: SEM observation after laser-impact on a silicated silica sand.

This test is simulated by a 1D-axisymmetrical model:

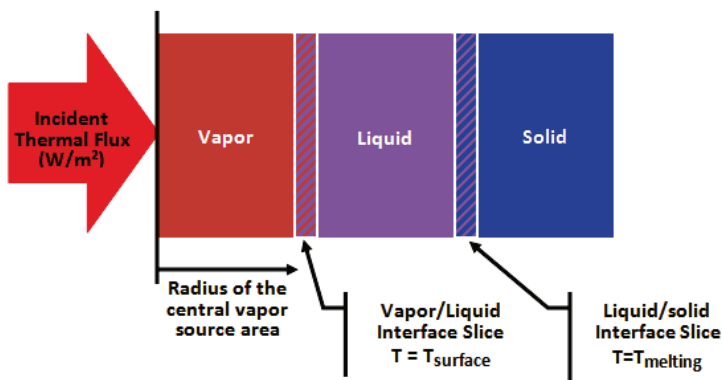

Figure 15: Principle of the 1D-axisymmetrical model

In case of stationary conditions, the incident thermal flux is used for heating the domain according to the following equation:

$$\Phi_i = \dot{m}_{vap} \cdot [L_v + C_{pl}(T_s - T_m)] + L_v + C_{pl}(T_s - T_m)$$

where Φ_i is the incident thermal flux and \dot{m}_{vap} the weight flux of vapor, the kinetic for vaporization respecting:

$$\dot{m}_{vap} = \sqrt{\frac{M}{2\pi R T_s}} \cdot P_{Sat} \cdot (1 - \beta_r)$$

with β_r , designed as “back-scattering coefficient” and acting as an adjustment variable. Then, according to Clapeyron’s formula:

$$P_{Sat} = P_0 \left[\frac{ML_v}{R} \left(\frac{1}{T_0} - \frac{1}{T_s} \right) \right]$$

$$L_v + C_{pl}(T_s - T_m)$$

heating of the liquid + vaporization

$$L_v + C_{pl}(T_s - T_m)$$

heating of the solid + melting

The incident thermal flux Φ_i can be adjusted in the modeling according to different conditions. For instance it can be considered constant in order to represent the impact of a laser beam or it can reproduce the wave-form of an actual fuse interrupting test.

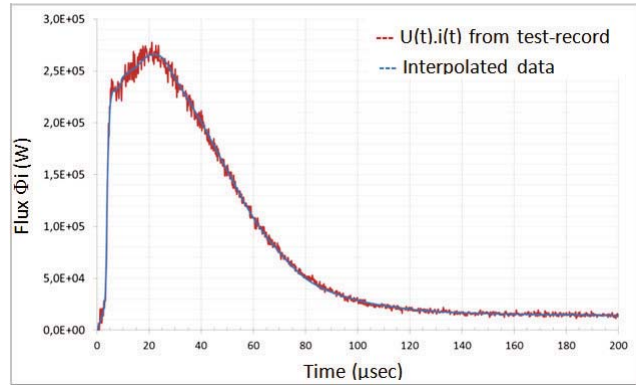

Figure 16: Incident flux calculated from $U(t) \cdot i(t)$ for a single reduced section.

The modeling will give interesting outputs such as temperatures, pressures and melted area:

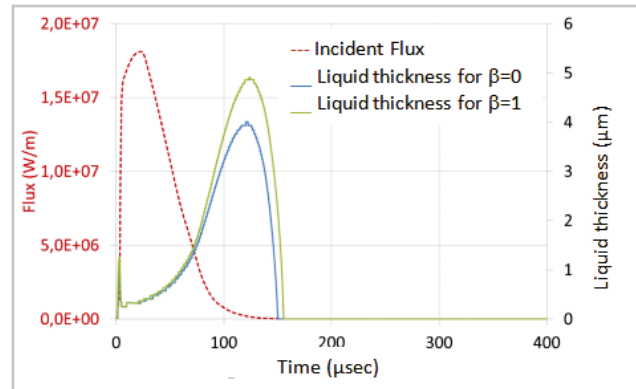

Figure 17: Melted area thickness along the time.

This information is interesting in designing the fuse-element. Furthermore, study of the resistivity of the material will be included to understand the risks of re-ignition.

Conclusion

The fuse, which is a very old component, since the first patents by Edison and Swan were registered as early as 1881, is still supporting investigations and innovations. But knowledge is probably more difficult to reach now than in the past. This paper gives a demonstration of these difficulties. In order to solve the problem of the specific operation of fuses under high di/dt , in VSI-converters, we have to couple several different physics, such as electronics, spectrometry, thermodynamics and so many connected scientific domains. It has not been possible to enter into the details in this short paper, but behind this very global overview, there is deep knowledge. Of course all the questions haven't been answered yet and some answers pose new questions. Life is like that. More specifically, concerning fuse protection for VSI-converters, MERSEN's engineers have improved their knowledge about transition from pre-arcing to arcing and the risks of re-ignition. Their job is now to draw out the right experience to propose the right fuse to the customer. There is no doubt that they can.

Bibliography

- [1] J. NASIŁOWSKI. Unduloids and striated disintegration of wires. *In Third Conference on the Exploding Wire Phenomenon*, Boston, pages 295–313, 1964.
- [2] P. GRANEAU. Wire explosions. *Physics Letters A*, 120(2):77–79, Feb. 1987.
- [3] H. ASPDEN. The exploding wire phenomenon. *Physics Letters*, 107(5):238–240, Feb. 1985.
- [4] J.G. TERNAN. Stresses in rapidly heated wires. *Physics Letters A*, 115(5):230–240, Apr. 1986.
- [5] A. COULBOIS. Etude de la transition préarc-arc dans les éléments fusibles. *Thèse de Physique des plasmas, Electrotechnique*. Clermont-Ferrand 2015.
- [6] V. V. SEMAK, G. A. KNOROVSKY, D. O. MAC CALLUM and R. A. ROACH. Effect of surface tension on melt pool dynamics during laser pulse interaction. *J. Phys. D: Appl. Phys.*, **39**, pp. 590–595. 2003.
- [7] A. MATSUNAWA, V. SEMAK. The simulation of front keyhole wall dynamics during laser welding. *Journal of Physics D-applied Physics - J PHYS-D-APPL PHYS*, vol. 30, no. 5, pp. 798-809, 1997.
- [8] J. GIRARDOT, N. RANC, M. SCHNEIDER, Ph. LORONG, L. ILLOUL, L. BERTHE, V. FAVIER. Procédé de perçage par laser : comparaison entre des données expérimentales et une simulation 2D basée sur la méthode CNEM. *21st French Congress of mechanics, Bordeaux*. 2013.

Conference: 10th International Conference on Electric Fuses and their Applications

Organized by: Dresden University of Technology
Postfach 100 920
01076 Dresden, Germany

Copyright

This work is copyrighted in its entirety. Any usage in violation of the narrow boundaries of copyright law without the prior approval of the organizer is prohibited and is punishable by law. This applies especially to copies in any form (photocopy, microfilms or any other practices) translations, as well as storing and processing with electronic media.

The organizing committee of the conference and organizer are not responsible for the opinion expressed in the papers published in this Program and Abstracts. The contents of the paper express entirely the views of the authors. All copying, reprint or reproduction requests should be addressed to the Dresden University of Technology. All rights reserved. Copyright: Dresden University of Technology.

Frankfurt am Main, Germany
September, 2015